

Stream™ Platform Instructions for Use

IFU-002 Ver. 9

Origin™ Catalogue #: LP-N1001; Stream™ App Catalogue #: LP-S1002;

Calibration Pack Catalogue #: LP-C1001; Minimum Software Version #: v2.1.0.



NERv Technology Inc. (D.B.A.) FluidAI Medical
809 Wellington St. N., Unit 2,
Kitchener, ON, Canada N2H 5L6
Tel: 1-877-660-6378
Email: info@fluidai.md

Proprietary Information

This document contains proprietary information, which is protected by copyright.

Patents and Trademarks

The product names enlisted in this manual may be trademarks of their respective owner.

Android is a trademark of Google LLC.

FluidAI and *FluidAI*'s Logo are trademarks of *FluidAI* Medical.

Stream™ App and *Origin™* are trademarks of *FluidAI* Medical.

Patent-pending: WO2020191494A1.

Copyright

Copyright © 2022 *FluidAI Medical*. All Rights Reserved.

To support the intended use of the product described in this publication, the user of the product is permitted to copy this publication, for internal distribution only.

Technical Assistance

For technical assistance contact your local *FluidAI Medical* representative or contact *FluidAI* directly by calling +1 (877) 660-6378 or emailing **support@fluidai.md**.

Table of Contents

Table of Contents	i
1 Introduction	3
1.1 Manual Conventions	3
1.2 <i>Stream™ Platform</i> Components	3
2 Safety	6
2.1 General Safety	6
2.2 Electrical Safety	6
2.3 Usage Safety.....	7
2.4 Chemical and Biological Safety	8
3 System Overview.....	9
3.1 Intended Use.....	9
3.2 Indications for Use	9
3.3 Contraindications	9
3.4 Principles of Operation.....	9
3.5 Patient Data Protection.....	10
3.6 Compatible Drainage Systems	10
3.7 Measured Parameters	11
3.8 Calculated Parameters	12
3.9 Clinical Benefit	12
3.10 Anastomotic Leak Risk Category Overview.....	13
4 <i>Stream™</i> Software Application.....	15
4.1 Overview	15
4.2 Wireless Connectivity	15
4.3 <i>Stream™ App</i> Dashboard screen.....	15
4.4 Patient Screen and Device Details Screen.....	17
4.5 Soft Reset	21
4.6 Status Indicators	21
4.7 Date/Time Clock	22
4.8 Settings Screen	22
4.9 Servicing.....	24
5 <i>Origin™</i> and <i>Stream™</i> Operation Instructions	24
5.1 <i>Stream™ App</i> Initial Setup.....	24
5.2 Unpackaging of <i>Origin™</i>	26

5.3	Turning “ON” <i>Origin™</i> and Attachment of <i>Origin™</i> to the Patient’s Wound Drain ...	28
5.4	Creation of Patient Record on <i>Stream™ App</i>	35
5.5	Pairing <i>Origin™</i> to the <i>Stream™ App</i>	38
5.6	Calibration of <i>Origin™</i>	42
5.7	Preparation for Calibration.....	43
5.8	Calibration Procedure.....	45
5.9	Anastomotic Leak Risk Category Feature	59
5.10	Over the Air (OTA) updates.....	60
5.11	Reviewing Patient Data.....	62
5.12	Disconnecting <i>Origin™</i> from the Patient’s Wound Drain.....	64
5.13	Disposal of <i>Origin™</i> Device.....	65
5.14	Sending Feedback through the <i>Stream™ App</i>	65
6	System Overview.....	67
6.1	Overview	67
6.2	Device Power	67
6.3	Device LED Indicators.....	67
6.4	Calibration Accessories.....	68
7	Care and Maintenance of <i>Origin™</i>	69
7.1	General	69
7.2	Cleaning and Disinfection.....	69
7.3	Servicing and Maintenance	69
7.4	Operating and Storage Environment.....	69
7.5	Consumables Replacement	72
8	Troubleshooting and Error Messages	72
8.1	General Troubleshooting.....	72
8.2	<i>Stream™</i> Application Error Messages.....	73

1 Introduction

This section provides introductory information on Stream™ App and Origin™.

1.1 Manual Conventions

This manual is applicable to Stream™ App, Origin™, and associated accessories.

Throughout this manual, the following conventions will be used to highlight important notes and safety concerns:



NOTE

Notes will be used to indicate important information.



CAUTION!

Caution will be used to indicate conditions, hazards, or unsafe practices that may result in damage to the device, loss of data, and/or generation of inaccurate results.



WARNING!

Warning will be used to indicate conditions, hazards, and/or unsafe practices that may result in possible injury to the user.

1.2 Stream™ Platform Components

Stream™ Platform consists of the following components: Origin™ inline device, Stream™ software application (Stream™ App), and associated calibration syringes. Origin™ is a single-use medical device intended to be used with existing closed wound drainage systems to continuously monitor and analyze the pH, temperature, and electrical conductivity of wound drainage (See full *Intended Use* statement under **Section 3.1**). Origin™ connects to Stream™ App via Bluetooth. Stream™ App is a mobile application that is pre-installed on an Android mobile device supplied by FluidAI Medical (FluidAI Medical's mobile device). Calibration syringes will be provided separately by FluidAI Medical and will be used to calibrate the system to ensure the accuracy of sensor measurements.

This manual will provide information to assist trained operators in the safe and effective operation of the Stream™ Platform.

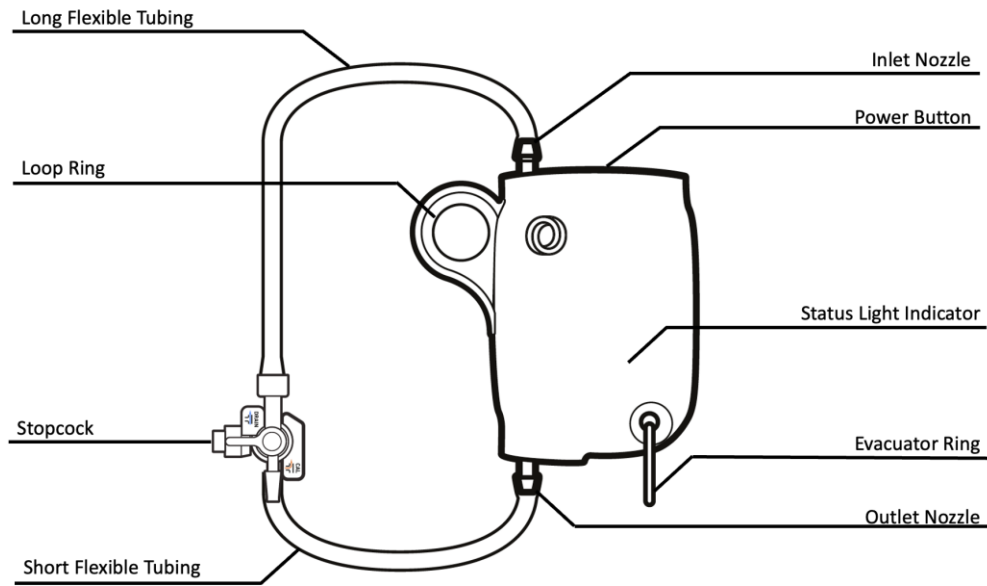

Figure 1: Origin™ Inline Device

Origin™ consists of the following main components as outlined in **Table 1**:

Table 1: *Origin™*'s Components

Component	Purpose
Inlet Nozzle (white)	Allows for the flow of fluid into the device's flow cell (where the pH and electrical conductivity sensors are located)
Outlet Nozzle (blue)	Allows for the flow of fluid out of the device's flow cell and into the short flexible tubing which connects to the evacuator
Long Flexible Tubing (120mm Silicone Tube)	Used to connect the inlet nozzle to the 3-way stopcock
Short Flexible Tubing (85mm Silicone Tube)	Used to connect the outlet nozzle to the evacuator
Power Button	Used to turn the device on and enhance wireless pairing with <i>Stream™ App</i> through a Bluetooth connection
3-way Stopcock	Used to facilitate the calibration of <i>Origin™</i> and to connect to the patient's wound drain
Status Light Indicator	Allows user to infer the battery status and connectivity status of <i>Origin™</i>
Evacuator Ring (or Reservoir Ring)	Used to securely attach <i>Origin™</i> to the evacuator/reservoir
Loop Ring	The 2" safety pin can be secured here to attach <i>Origin™</i> to the patient's gown
Tube Clamp	Used to clamp the flexible tubing of the wound drainage system during attachment and detachment of <i>Origin™</i>
2" Safety pin	Used to securely attach <i>Origin™</i> to the patient's gown

Internal components of *Origin™* include electronic circuitry, batteries, and a flow cell with the pH, temperature, and electrical conductivity sensor modules.

For the proper use of *Stream™ Platform*, the following components are necessary:

- *Origin™* inline device: a single-use disposable device used to continuously measure pH, conductivity, and temperature of abdominal drainage and relay data to the user by interacting with the *Stream™* software application.
- Calibration accessory syringes: a set of three syringes prefilled with calibrators used to calibrate *Origin™*'s sensors and ensure the accuracy of measurements.
- *Stream™* software application: an application that is pre-installed on a compatible Android mobile device provided by *FluidAI Medical* and is used to interact with *Origin™* and view patient data.

NOTE



- *FluidAI Medical's* Mobile Device (containing *Stream™ App*) and the Calibration Syringes are packaged separately from *Origin™*.
- *Stream™* can only be used with the mobile device provided by *FluidAI Medical*.

Please take that time to read and understand all instructions in this manual before operating the system.

This system is indicated for use only by health care providers in hospitals or other healthcare facilities (See full *Intended Use* and *Indications for Use* statements under **Section 3**). Health care providers include physicians, nurses, and medically trained professionals.

Stream™ Platform must only be used in accordance with safety and operating instructions as outlined within this manual, and only for the purposes for which the device is intended.

2 Safety

This section will provide essential safety information for using *Stream™* Platform (which includes: *Origin™*, *Stream™ App* (preinstalled on *FluidAI Medical*'s mobile device), and associated calibration accessory syringes). This section includes a list of warning and caution messages.

2.1 General Safety



WARNING!

- *Stream™* Platform is intended for use by competent users as dictated by **Section 3.1 - Intended Use**.
- Do not use *Stream™* Platform until you have reviewed and fully understood the material presented in this instruction manual.
- User should retain a copy of this Instruction Manual for future reference. The Instruction Manual is available online through provided QR code and is printer friendly.
- Follow all safety and use instructions and do not attempt to operate *Stream™* Platform improperly. Improper use may lead to serious injury.
- Only use *FluidAI Medical* supplemented calibration fluids and accessories.
- Do not attempt to service *Stream™* Platform beyond any troubleshooting steps described in the instruction manual and/or instructions provided by authorized *FluidAI Medical* Representatives.
- *Stream™* should be serviced by qualified service personnel only.

2.2 Electrical Safety



WARNING!

- To reduce the risk of electric shock, do not attempt to open or tamper with *Origin™* or the provided mobile device.
- There are no user-serviceable parts inside *Origin™*. Do not attempt to open, remove components, or repair *Origin™*.
- Dropping *Origin™* may result in damage. Always inspect *Origin™* for any signs of potential damage. If any damage is apparent, do not use the device to avoid the risk of electrical hazard.
- If *Origin™* feels unusually warm to the touch, usage must be stopped immediately, and the device must be replaced.
- Fluid spillage into the internal module of *Origin™* may damage it or result in a fire or shock. If spillage occurs, usage of the device must be stopped immediately, and the device must be replaced.
- Do not immerse *Origin™* in water or liquids.

**NOTE**

- *Origin™* should not produce excessive heat under indicated use.
- The rated operating atmospheric pressure range for *Origin™* is 760 mmHg.
- *Origin™* should only be operated at altitudes $\leq 2000\text{m}$ and is for use in a Pollution Degree 2 environment.

2.3 Usage Safety

**WARNING!**

- *Origin™* must not be used during radiographic imaging including CT scans, PET scans, MRI scans, X-rays, etc.
- Use only accessories (tubing, calibration syringes, and stopcocks) supplied by *FluidAI Medical*. Substitution of non-approved accessories may cause the system to perform improperly or may result in injury to the patient or operator.
- If leakage is seen at *Origin™* or stopcock, usage must be stopped immediately, and the device must be replaced as per these instructions.
- Device may overheat and cause skin burns. Avoid **direct** skin contact between the device and patient's skin for a prolonged period of time (≥ 1 minute). If device overheats, remove immediately.
- Device surface temperature may reach 52°C . Follow instructions in device attachment and setup to avoid prolonged contact with patient's skin.
- No modification of this equipment is allowed. Do not attempt to modify components of *Stream™ Platform*. Any modification may cause the system to perform improperly or may cause injury to the patient or operator.
- Do not attempt to install any third-party applications on the mobile device provided by *FluidAI Medical*.
- To avoid the possibility of damage, do not store *Stream™ Platform* outside of the specified environmental operating conditions.
- Do not overly bend or kink the flexible tubing attached to *Origin™*.
- Do not sterilize or autoclave any of *Stream™ Platform*'s system components.
- Do not re-use *Origin™* on more than one patient. *Origin™* is a single-use device.
- Do not attempt to use *Origin™* with a non-compatible drain.
- Use of this Device adjacent to or stacked with other devices/equipment should be avoided because it could result in improper operation of one or more of the equipment/devices. If such use is necessary, this equipment and the other equipment should be observed to verify that they are operating normally.
- **Improper orientation of the stopcock can impede drainage and result in harm to the patient.** The "OFF" indicator must be always positioned toward the positive pressure cap/infusion port of the 3-way stopcock, in "DRAIN" position, unless the user is conducting a calibration, where it is to be positioned at "CAL" to allow for flow between the positive pressure cap/infusion port and *Origin™*.

**WARNING!**

- Do not invert the stopcock. The short flexible tubing must be connected to the evacuator while the 3-way stopcock must be connected to the patient's drain. **Inversion of the stopcock can result in incorrect flow of calibration fluid into the patient during a calibration which can harm the patient.**
- Do not leave the tube clamp in place after attachment of *Origin™*. **Neglecting to remove the tube clamp will impede drainage and result in harm to the patient.**

2.4 Chemical and Biological Safety

**WARNING!**

- Observe all precautionary information printed on the calibration packs and SDS.
- Follow your institution's personal protective equipment (PPE) and infection control procedures when handling, operating, cleaning, and disinfecting *Stream™* Platform.
- Follow your institution's standard procedure and local regulations for device disposal.
- Follow your institution's personal protective equipment (PPE) and infection control procedures if fluid spillage from the device occurs during attachment/detachment to/from the patient.
- Dispose of all waste according to standard hospital procedures and local regulations.

3 System Overview

This section includes information about system features, components, and requirements.

3.1 Intended Use

Stream™ Platform system comprising of *Origin™*, *Stream™ App*, and calibration accessory syringes is a portable system indicated for use by physicians and medical practitioners to measure the pH, conductivity, and temperature of wound drainage continuously and noninvasively during postoperative recovery.

3.2 Indications for Use

Origin™ is indicated for use in conjunction with a compatible drainage system. *Origin™* is compatible with various abdominal closed drainage suction systems commonly being used in the medical industry during post-operative recovery. Measured data provides additional information that may prompt earlier diagnostic testing and/or earlier intervention as per current standard of care.

3.3 Contraindications

There are currently no known contraindications for *Stream™ Platform*.

3.4 Principles of Operation

The system (*Stream™ Platform*) consists of three main components: *Origin™*, *Stream™ App* (preinstalled on *FluidAI's* mobile device), and calibration accessory syringes. Upon postoperative attachment as described in **Section 3.2**, the system provides real-time measurements of pH and electrical conductivity of the drainage fluid.

Origin™ will noninvasively and continuously monitor and report the pH and electrical conductivity (EC) of the fluid that passes through its flow cell. Temperature is also measured and used for temperature correction of pH and EC measurements. This data is relayed to the *Stream™ App* on *FluidAI Medical's* mobile device allowing healthcare providers to view patient data. The *Stream™ App* will prompt users to conduct calibrations daily using the calibration accessory syringes provided by *FluidAI Medical* to ensure the accuracy of measurements. Calibration syringes will be attached to the positive pressure cap/infusion port on the stopcock (see **Figure 24**) as part of the calibration process.

3.5 Patient Data Protection

FluidAI Medical's mobile device are password/passcode protected and have an auto-lock period to prevent unauthorized access.



CAUTION!

- *FluidAI Medical's* mobile devices are password protected to protect patient data. Users must configure password settings to abide by the institution's data protection policies.
- User must abide by the institution's patient data protection policies.
- User will not be able to take screenshots of the patient monitoring screen in order to protect patient data. However, when creating support tickets, user may include screenshots. If user chooses to include screenshots, **they must redact all protected health information** prior to uploading screenshots from *Stream™ App* to support tickets. The *Stream™* application facilitates screenshots during the creation of a ticket as well as a prompt to redact any Protected Health Information.
- Exported patient data is password protected. The user will be prompted to set a password upon export.

3.6 Compatible Drainage Systems

Origin™ is compatible with passive and active closed wound drainage systems. This includes the drainage systems outlined in Table 2: List of Compatible Drains and their equivalents.

Table 2: List of Compatible Drains

Compatible Drains	Compatible Drain Sizes
(Perforated/Fluted/Hemaduct) Flat (Hubless) Silicone Wound Drain	4 mm, 7mm, 10 mm
(Perforated/Fluted/Hemaduct) Round (Hubless) Silicone Wound Drain	10Fr -19 Fr
Round PVC Wound Drain	10Fr -19 Fr



NOTE

- Other abdominal drains with equivalent flexible tubing diameters to the above may also be used with *Origin™*.



WARNING!

- *Origin™* cannot be used with open wound drains such as the Penrose drain.

Commonly used drains that are compatible as dictated by **Table 2** include (but is not limited to):

- Cardinal Health Jackson-Pratt Perforated Flat Drains (all sizes between 4mm and 10mm)
- Cardinal Health Jackson-Pratt Perforated Round Drains (all sizes between 10Fr and 19 Fr)
- Cardinal Health Jackson-Pratt Channel Flat Drains (all sizes between 4mm and 10mm)
- Cardinal Health Jackson-Pratt Channel Round Drains (all sizes between 10Fr and 19 Fr)

Table 3: List of Compatible Evacuators

Compatible Evacuators	Volume
Silicone Bulb Evacuator	100 cc, 150 cc, 200cc, 400 cc
Gravity Drainage Bags with Tube Adapter	500cc, 600 cc, 1000 cc, 2000cc

Commonly used evacuators that are compatible as dictated by **Table 3** include, but are not limited to:

- Cardinal Health Jackson-Pratt 100 cc Reservoir
- Cardinal Health Jackson-Pratt 400 cc Reservoir
- Cardinal Health Jackson-Pratt 3-Spring Reservoirs (only with silicone adapters)
- Bard 600cc Bile Bag with T-Tube Adapter

3.7 Measured Parameters

The measurement of the following parameters is considered essential to the system’s performance.



NOTE

- Electromagnetic disturbances due to nearby medical equipment may distort measured and calculated parameters. Electromagnetic disturbances may also lead to temporary loss of *Origin™* connectivity to the *Stream™ App*. User must remove all interfering equipment to re-establish connectivity.

pH

The pH of the drainage fluid is measured using an Ion-Sensitive Field Effect Transistor (ISFET). The ISFET measures the pH by directly measuring the activity of the H₃O⁺ ion:

$$pH = -\log a_{H_3O^+}$$

Typical pH meters with glass probes will measure the *concentration* of H₃O⁺ which, in some cases, is different than the *activity*. As such, there may be discrepancies when comparing pH readings from *Origin™* with typical glass pH meters.

The ISFET changes its surface potential in proportion to the pH of the solutions it is exposed to. This change in surface potential is measured differentially against a stable reference potential and can be converted to a pH reading by the following equation:

$$pH_{unknown\ solution} = \frac{E_{unknown\ solution}(mV) - E_{Standard\ A}(mV)}{Sensitivity_{ISFET}(mV/pH)}$$

Impedance

The impedance of the drainage fluid is defined as the ability of the fluid to resist electrical current. The impedance of the drainage fluid largely depends on the ionic species present in the fluid. Impedance is measured by applying a small, localized current through the drainage fluid in *Origin™*'s flow cell, measuring the potential response, and calculating the resulting specific impedance, ρ , via Ohm's law.

$$\rho\ (ohms.\ cm) = \frac{V\ (V)}{i\ (A)}\ C(cm)$$

3.8 Calculated Parameters

Electrical Conductivity (EC)

EC can be calculated from the measured impedance using the following relationship:

$$\kappa\ (mS/cm) = \frac{1}{\rho\ (ohms.\ cm)}$$

Temperature corrected EC readings can be activated/deactivated using the toggle in the "SETTINGS" screen (see Section 4.8- Settings Screen)

Temperature Correction for pH readings

Origin™ measures and automatically compensates for the actual temperature of the drainage fluid in its' flow cell in real-time. The *Stream™ App* calculates the temperature corrected pH and displays it by default using the following equation:

$$pH_{Temperature\ Corrected} = pH_{uncorrected} \times \frac{Fluid\ Temperature_{at\ point\ of\ measurent}}{Fluid\ Temperature_{at\ point\ of\ calibration}}$$

3.9 Clinical Benefit

The measured and calculated parameters (described in **Section 3.7** and **Section 3.8**) may provide physicians with an early indication of a developing postoperative complication such as an anastomotic leak, tissue inflammation, or ischemia in the peritoneal cavity or pelvis, and prompt earlier diagnostic testing and/or earlier intervention as per current standard of care.

It has been outlined in the literature that a postoperative decline in pH levels of peritoneal fluid from intra-abdominal drains can act as a clinically useful biomarker of anastomotic

failure after gastrointestinal surgery. Measurement of drainage fluid pH can be used as a pathogenic marker of ischemia/deficient tissue perfusion and local inflammation around the anastomosis which is indicative of poor anastomotic healing. **Table 4** summarizes the findings of various research publications showcasing how pH measurements can be used to identify AL early.

Table 4: Overview of research publications outlining the potential benefit of using pH to predict anastomotic leakage after gastrointestinal surgery.





First Author, Year	Study Design	Number of Patients Enrolled	Method	Results
Millan ¹ , 2006	Prospective Study	90	An intraluminal tonometry catheter was placed superior to the anastomosis and was used to measure pH at postoperative hours (POH) 24 and 48 after the surgical procedure.	A significant decrease in pH was seen at postoperative hour 24 in patients who were later diagnosed with a leak. A low pH (<7.28) measured using this method yielded a specificity of 98.3% and a sensitivity of 28.1%.
Yang ² , 2013	Prospective Study	753	Peritoneal drain samples were collected, and pH was measured daily between postoperative day 1 to postoperative day 12	pH of abdominal drainage was significantly lower in patients who leaked. pH <6.978 on postoperative day 3 yielded a specificity of 94.7% and a sensitivity of 98.7%.
Molinari ³ , 2019	Prospective Study	173	Peritoneal drain samples were collected, and pH was measured on postoperative day 1 and postoperative day 3	pH < 7.53 on postoperative day 1 and pH < 7.21 on postoperative day 3 yielded a specificity of 97.0% and a sensitivity of 93.75%.

¹Millan M, García-Granero E, Flor B, García-Botello S, Lledo S. Early prediction of anastomotic leak in colorectal cancer surgery by intramucosal pH. *Dis Colon Rectum*. 2006 ;49(5) :595-601. Doi :10.1007/s10350-006-0504-7. ²Yang, L., Huang, X.-E., Xu, L., Zhou, X., Zhou, J.-N., Yu, D.-S., ... Guan, X. (2013). Acidic Pelvic Drainage as a Predictive Factor For Anastomotic Leakage after Surgery for Patients with Rectal Cancer. *Asian Pacific Journal of Cancer Prevention*, 14(9), 5441–5447. Doi: 10.7314/apjcp.2013.14.9.5441. ³Molinari E, Giuliani T, Andrianello S, et al. Drain fluid's pH predicts anastomotic leak in colorectal surgery: Results of a prospective analysis of 173 patients. *Minerva Chir*. 2020;75(1):30-36. Doi:10.23736/S0026-4733.19.08018-0.

3.10 Anastomotic Leak Risk Category Overview

Various features from *Origin™*'s measured parameters are used to calculate an Anastomotic Leak Risk Category (a.k.a. *Leak Risk*) to estimate the overall probability that a patient may develop an anastomotic leak. The *Leak Risk* presented on the *Stream™ App* is not a diagnostic or predictive tool, it is an optional and validated feature intended to promote earlier diagnostic testing, as per the standard of care, for higher risk patients. This *Leak Risk* was developed during clinical testing using *Origin™* and should be used in conjunction with standard diagnostic testing modalities for anastomotic leak diagnosis. For easy interpretation, the *Leak Risk* is depicted by four categorical grades as seen in **Table 5** below.

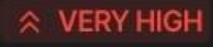
Table 5: Patient Anastomotic Leak Risk Category and descriptions

AL Leak Risk Category	Description
 VERY LOW	<i>Origin™</i> 's measured parameters indicate that this patient is at a VERY LOW risk of developing an anastomotic leak
 LOW	<i>Origin™</i> 's measured parameters indicate that this patient is at a LOW risk of developing an anastomotic leak
 HIGH	<i>Origin™</i> 's measured parameters indicate that this patient is at a HIGH risk of developing an anastomotic leak
 VERY HIGH	<i>Origin™</i> 's measured parameters indicate that this patient is at VERY HIGH risk of developing an anastomotic leak
 GATHERING	<i>Origin™</i> has not yet gathered enough data to predict the patient's risk of developing an anastomotic leak. A minimum of one hour of continuous non-erroneous data is required to calculate the patient's <i>Leak Risk</i> .



NOTE

- The initial *Leak Risk* is available within post-operative hour (POH) 24 and is calculated every hour thereafter.
- Continuous non-erroneous measurements are required for accurate *Leak Risk* calculations.
- Blockage of the drain or improper drain function can interfere with the accuracy of the calculated *Leak Risk*.
- Failing to calibrate *Origin™* can interfere with the accuracy of the measured parameters which in turn can interfere with the accuracy of the calculated *Leak Risk*.
- *Leak Risk* is an optional feature that requires the user to input specific parameters to be available for use.
- The ASA score, surgery start date, surgery time, surgery duration, and surgical approach are “recommended” fields. However, they are required to properly calculate the patient's *Leak Risk* (See Section 3.10). Inaccurate input can result in an inaccurate *Leak Risk* calculation. Additional user input of other surgery/patient parameters may be required as *Leak Risk* feature updates become available.

4 *Stream™* Software Application

This section includes information about *Stream™* App.

4.1 Overview

Stream™ is an application pre-installed on *FluidAI Medical*'s mobile device. Operation and management of *Origin™* can only be performed via the *Stream™* App. *Stream™* displays real-time data that is captured by *Origin™* and is used to calibrate *Origin™*. Patient records can be created within the *Stream™* App to allow users to store, access, and interpret data from *Origin™*.

4.2 Wireless Connectivity

Bluetooth Low Energy (BLE) is used to transfer data between *Stream™* App and *Origin™* during use. *Origin™* needs to be within 5 meters (line-of-sight) of *FluidAI Medical*'s mobile device to transfer data during use. If the *Stream™* App is failing to connect with *Origin™*, try to move closer or remove any obstructions such as equipment that is in the direct line-of-sight between *Origin™* and the mobile device containing *Stream™*. If problems persist, see *Section 8- Troubleshooting and Error Messages* or contact your local *FluidAI Medical* representative.

4.3 *Stream™* App Dashboard screen

The *Stream™* App's Dashboard screen is shown below.

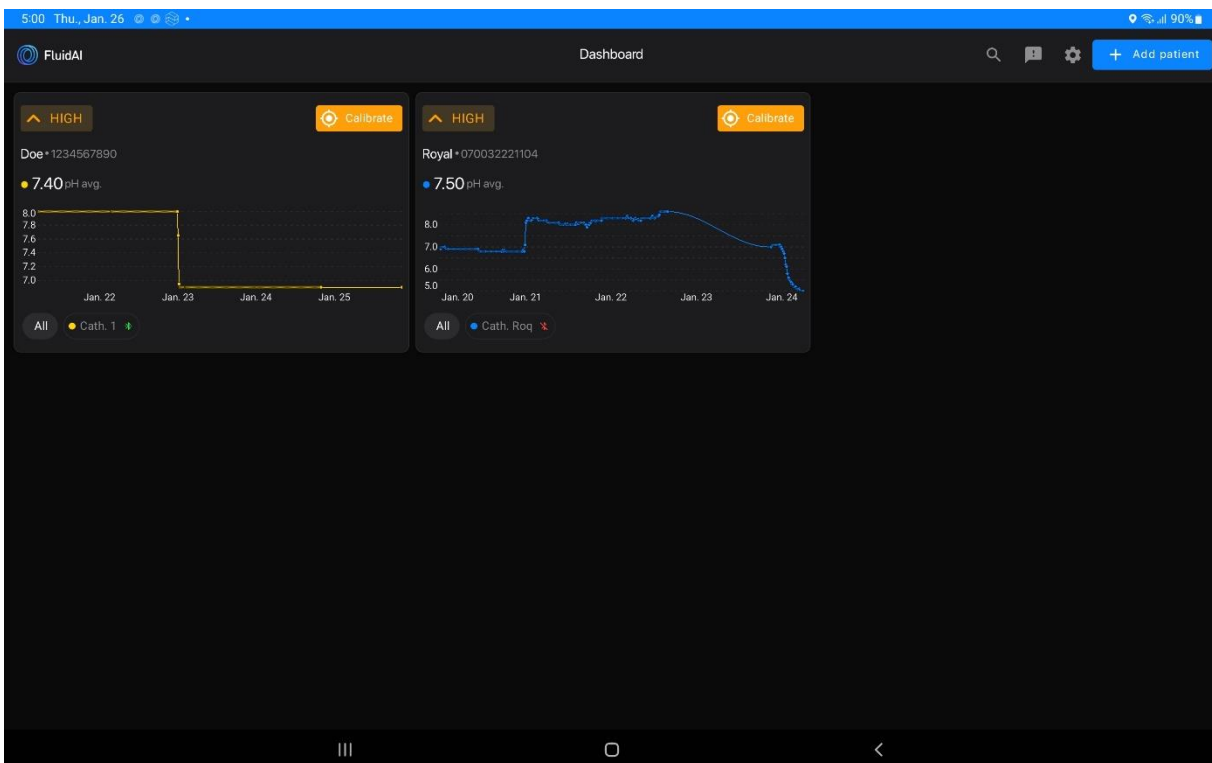

Figure 2: Dashboard Screen on *Stream™*

Stream™'s dashboard screen will display a summary of a given patient's details. This includes the following:

- Number of devices/drains associated with a patient (and their respective drain ID)
- Continuous pH and electrical conductivity (EC) measurements (displayed values of up to 24-hours)
- Average pH and EC measurements for all pH/EC data measured by *Origin™*
- A *leak risk/ AL Leak Risk Category* based on data measured by *Origin™*
- Patient name
- Patient MRN

The dashboard screen will show all patients that were created on the application. No restrictions exist on the number of patients that can be created on the *Stream™ App*.

The search bar on the top of the dashboard can be used to search for specific patients by name, room number/location, or medical record number (MRN) as shown in **Figure 3** below.

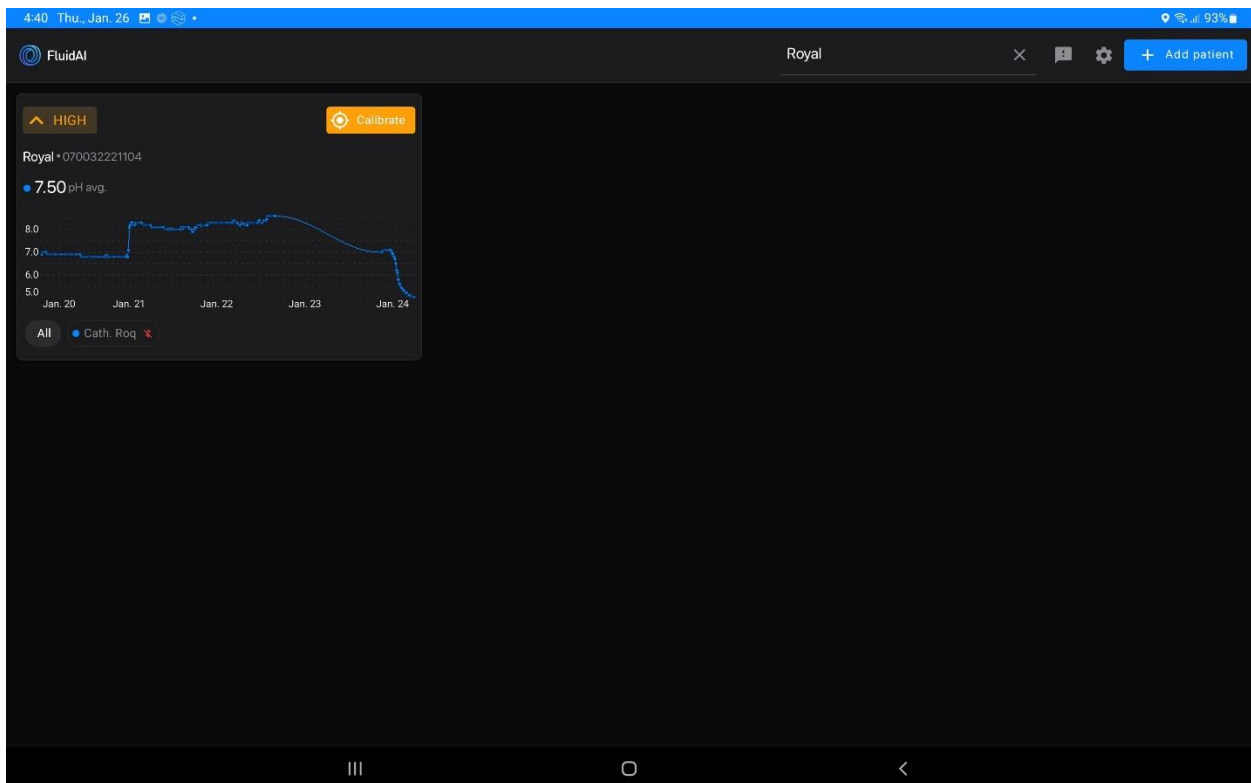

Figure 3: Search bar on the *Stream™ App*

The Setting Screen, shown below can be accessed by selecting the “⚙️” button on the top right corner on the dashboard screen. The user can access the regulatory label and third-party license, change the temperature measurement unit (from Celsius to Fahrenheit/Kelvin or vice versa), export all patient data, delete all patient data, and send feedback to *FluidAI Medical* from the settings screen.

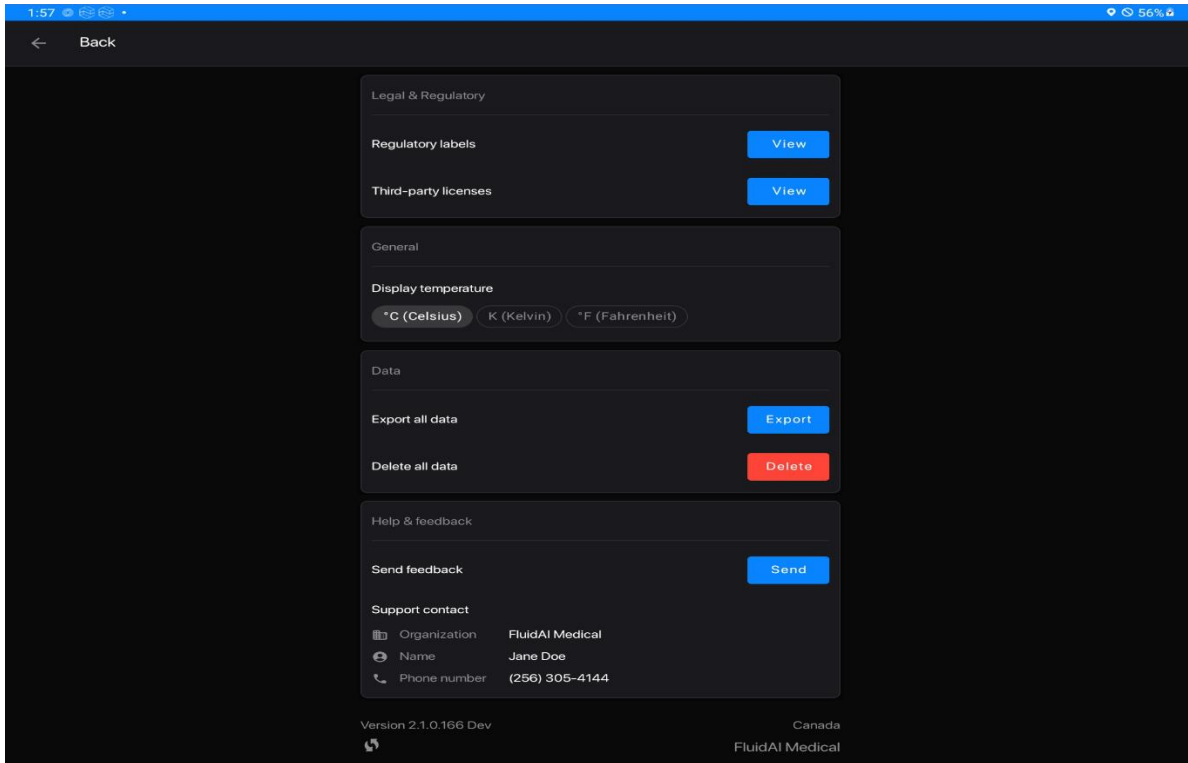

Figure 4: Stream™ App Settings Screen

A new patient can be created via the “+ Add Patient” button on the top right corner of the dashboard screen.

4.4 Patient Screen and Device Details Screen

Patient information can be reviewed by clicking on the patient card and going into the patient screen (see **Figure 5** below). **Table 6** outlines the different parts of the patient screen.

Table 6: Areas of Patient Screen on Stream™ App as per Figure 5

Area	Area Name	Purpose/Description
1	Patient information summary	This will display the patient’s name and MRN, Date of Birth, and Room, if provided. By selecting the dropdown menu “:” on the Patient Card, the user can link a new device to the patient, view all of the patient’s details, edit the patient’s details, Export the patient’s data, or delete the patient from <i>Stream™</i> .
2	Catheter Card	The catheter card will display all catheters attached to the patients, to which the <i>Origin™</i> devices are attached. The catheter ID will be displayed. The most recent device calibration along with the device status (Connected, Calibrated) will also be seen. A device falls under a catheter

Area	Area Name	Purpose/Description
		<p>card. Once a device has reached its active life and needs to be replaced, the device connected to the <i>Catheter Card</i> can be replaced with the new device. If a device is disconnected from <i>Stream™</i>, device status will appear on the catheter card.</p> <p>By selecting the dropdown menu “:” on the Catheter Card, the user can re-establish the connection between <i>Origin™</i> and <i>Stream™ App</i>, calibrate the device, edit the catheter ID, transfer devices from one patient to another if they have not yet been calibrated/attached, edit the card color, deactivate a device if it is no longer in use, and view more information about the device.</p> <p>Select “About device” to view more information such as the connection status, battery status, Bluetooth address, firmware version, serial number, uptime, and last calibration time/date) – See Figure 6 and Table 7 for more details.</p>
3	Date Filter	This allows the user to select the range of days of data to be displayed on the patient screen.
4	Leak Risk (<i>Anastomotic Leak Risk Category</i>)	<p>This shows a real-time indication based on <i>Origin’s™</i> continuous measurements of whether the patient is at risk of developing an anastomotic leak. Based on drainage fluid measurements, a <i>leak risk</i> category of “very low”, “low”, “high”, or “very high” will be given. “Gathering” indicates that <i>Stream™</i> has not collected enough data to predict the patient’s <i>leak risk</i>. The <i>leak risk</i> will be updated on an hourly basis. The patient’s current risk category will be displayed on the right side.</p> <p>An ASA score, surgery date, start time, duration, and surgical approach are required to calculate the patient <i>leak risk</i>.</p>
5	Real-time patient pH chart	<p>This shows the continuous pH measurements captured by <i>Origin™</i> within the date range assigned by the user under the date filter. The average, minimum, and maximum pH measurements will be displayed on the right side.</p> <p>By selecting “☐” on the top right corner of the <i>real-time patient pH chart</i>, the user can expand the pH chart for better visualization.</p> <p><i>Stream™</i> automatically hides data points on the chart that are out of range or are indicative of bubbles being present in the device flow cell.</p> <p>If multiple <i>Origin™</i> devices are being used for a single patient at the same time, the user can scroll up/down on the <i>real-time patient pH chart</i> to view data for each <i>Origin™</i> device separately.</p>
6	Real-time patient conductivity chart	This shows the continuous electrical conductivity measurements captured by <i>Origin™</i> within the date range assigned by the user under the date filter. The average,

Area	Area Name	Purpose/Description
		<p>minimum, and maximum electrical conductivity measurements will be displayed on the right side. By selecting “☰” on the top right corner of the <i>real-time patient conductivity chart</i>, the user can expand the chart for better visualization.</p> <p><i>Stream™</i> automatically hides data points on the chart that are out of range or are indicative of bubbles being present in the device flow cell.</p> <p>If multiple <i>Origin™</i> devices are used for a single patient the user can scroll up/down on the <i>real-time patient conductivity chart</i> to view data for each <i>Origin™</i>.</p>

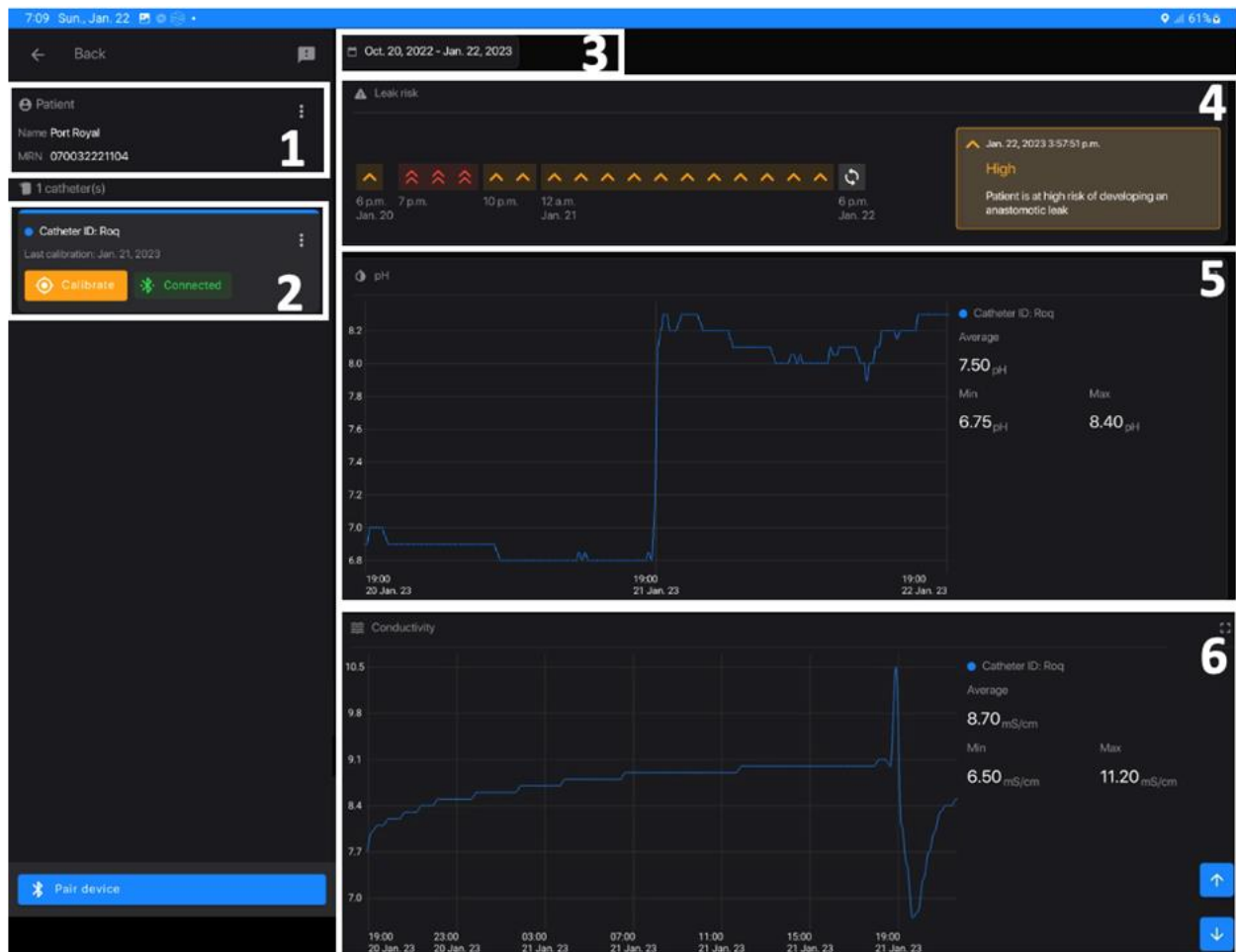

Figure 5: Patient Screen on Stream™ App

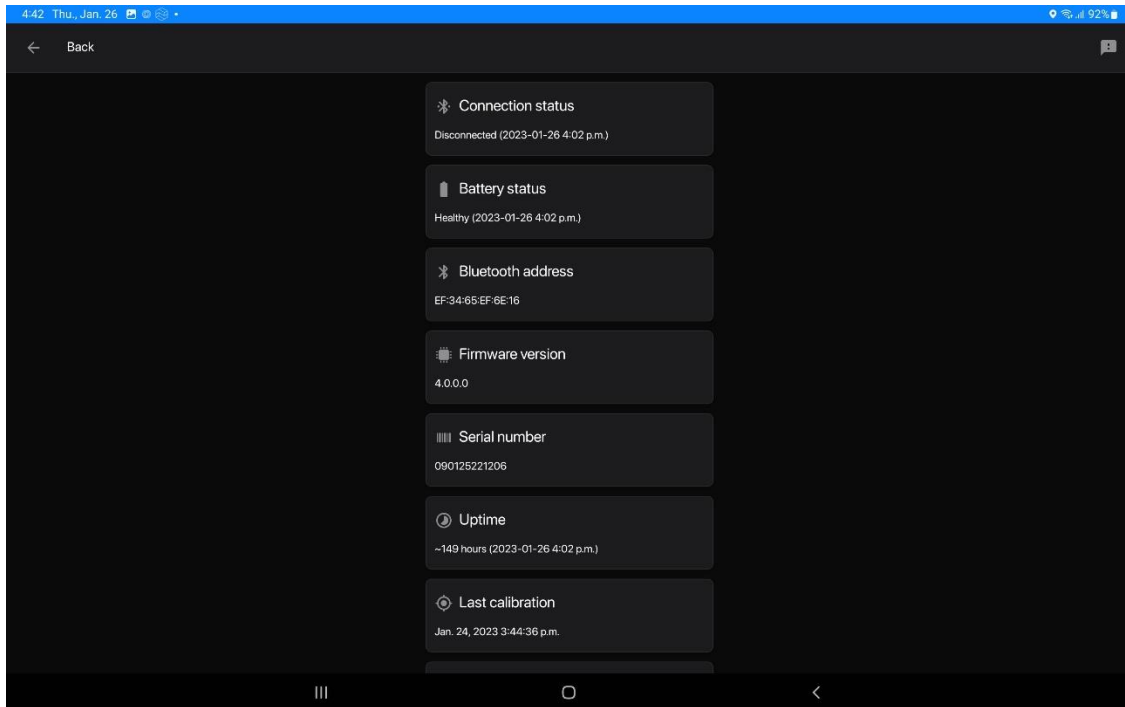

Figure 6: Device Details Screen



NOTE

- Information portrayed on the device detail screen will vary by device type and status.

Table 7: Device Details Description

Device Details	Description
Connection Status	<p>This will allow the user to identify if <i>Origin™</i> is paired with <i>Stream™</i>. The list below dictates what the different connection statuses mean:</p> <ul style="list-style-type: none"> • Connected- <i>Origin™</i> is paired to <i>Stream™</i> • Disconnected – Connection between <i>Origin™</i> and <i>Stream™</i> is lost. The last available date and time of a “connected” status may be provided
Battery Status	<p>This will allow the user to identify if the battery of the respective <i>Origin™</i> is viable or in critical condition. The list below dictates what the different battery statuses mean:</p> <ul style="list-style-type: none"> • Healthy- <i>Origin™</i> battery is viable/healthy. • Low (please replace device) – <i>Origin™</i> battery is low, and the device must be replaced. The date and time of the last available “healthy battery” status may be provided. • Critical (please replace device) – <i>Origin™</i> battery is critically low, and the device must be replaced. The date and time of the last available “healthy battery” status may be provided. <i>Origin™</i>

Device Details	Description
	will no longer transfer data to <i>Stream™</i> if the battery is in a critical state. <ul style="list-style-type: none"> • Unknown – <i>Origin™</i> battery status cannot be retrieved
Bluetooth Address	This will allow the user to view the Bluetooth address of the <i>Origin™</i> utilized. The Bluetooth address will vary depending on the device used.
Firmware Version	This will allow the user to view the current <i>Origin™</i> firmware version. The firmware version may vary depending on the hardware used for the respective device.
Serial Number	This will allow the user to view the unique serial number used to identify the <i>Origin™</i> utilized.
Uptime	This will provide the user with the approximate total operational time for the <i>Origin™</i> utilized.
Last Calibration	This will dictate the date and time of the most recent user calibration conducted.

4.5 Soft Reset

In the case of errors, the *Stream™ App* can be reset by turning the mobile device off and on again followed by clicking the *Stream™* icon on the dashboard screen of the mobile device. Alternatively, selecting the “” icon on the far left of the mobile device’s navigation bar will display recently opened apps. Sliding the application window upward will reset *Stream™*.

To exit *Stream™*, select the “” icon in the center of the mobile device’s navigation bar. This will return the user to the mobile device’s home screen, but *Stream™* will continue to run in the background.

Resetting *Stream™* preserves all the data that has been acquired by *Origin™*.

4.6 Status Indicators

The *Stream™ App* will alert users as to when *Origin™* is due for a calibration every 24 hours. When the *Origin™* that is linked to a patient needs to be calibrated, a “ Calibrate” button will appear on the catheter card as shown in **Figure 7** below.

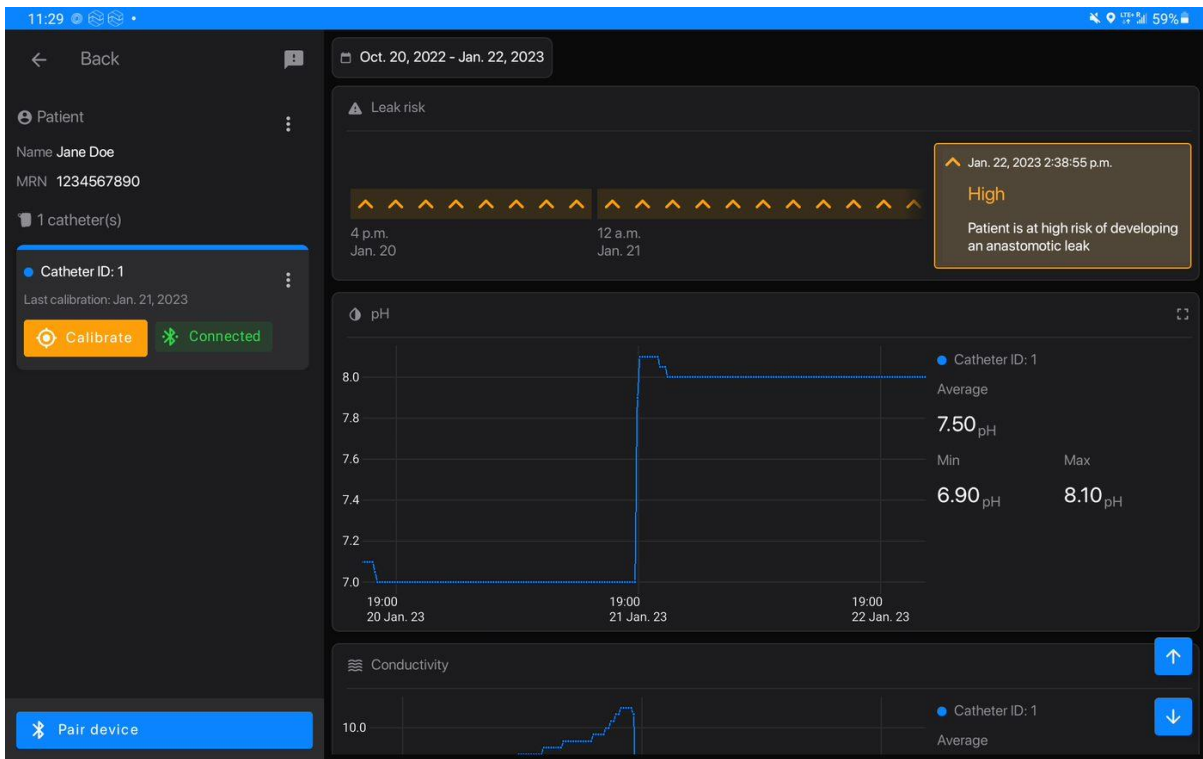

Figure 7: Orange Calibrate icon indicating that the Origin™ device is due for a calibration.

4.7 Date/Time Clock

Stream™ displays data based on the current local time that is set on the mobile device (top left corner). Please contact your local FluidAI Medical representative if the time on Stream™ or the mobile device is incorrect.

4.8 Settings Screen

This page contains the user-customizable settings for Stream™.

Table 8: Function of options on Stream™ App's setting screen as per Figure 8

Setting	Function
Regulatory Label	Allows user to view the regulatory label
Third-party License	Allows user to view the third-party license
Display temperature	Users can choose to display temperature units in either Celsius, Fahrenheit, or Kelvin
Delete all data	Deletes all patient data that is available on the Stream™ App. Data that is deleted cannot be retrieved
Export all data	Exports all data that is on the Stream™ App to be viewed on a PC
Send Feedback	Allows user to report their feedback to FluidAI Medical



CAUTION!

Deleting all data cannot be undone. Please contact your systems administrator or your local *FluidAI Medical* representative before doing so.

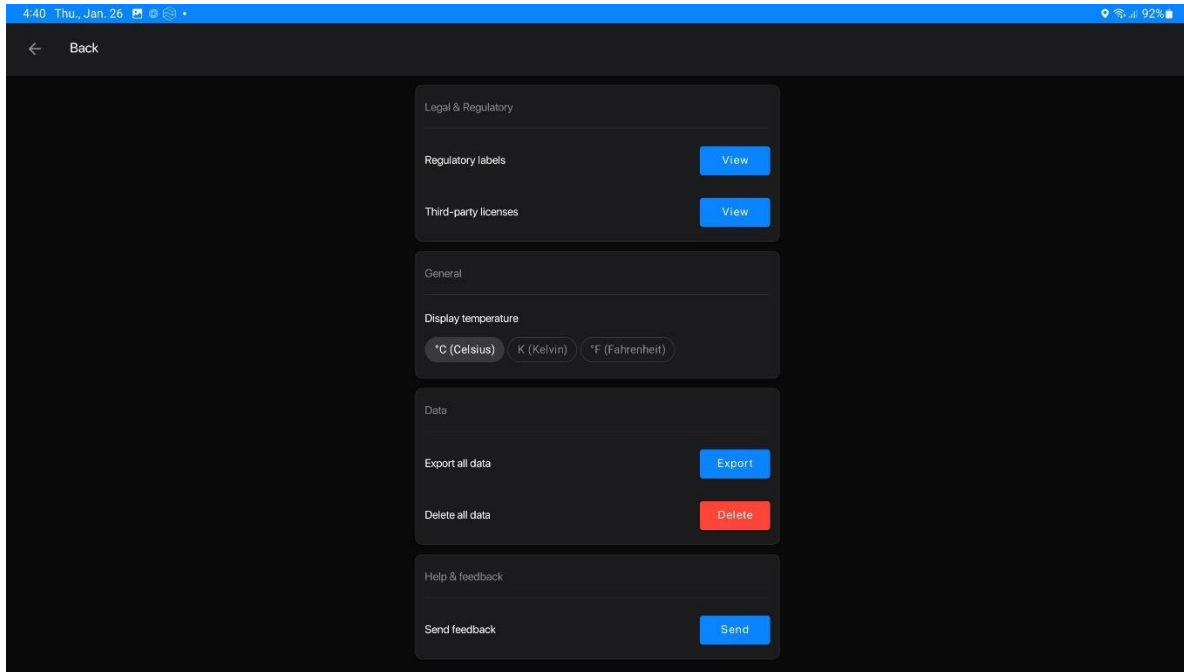

Figure 8: Stream™ App Settings Screen

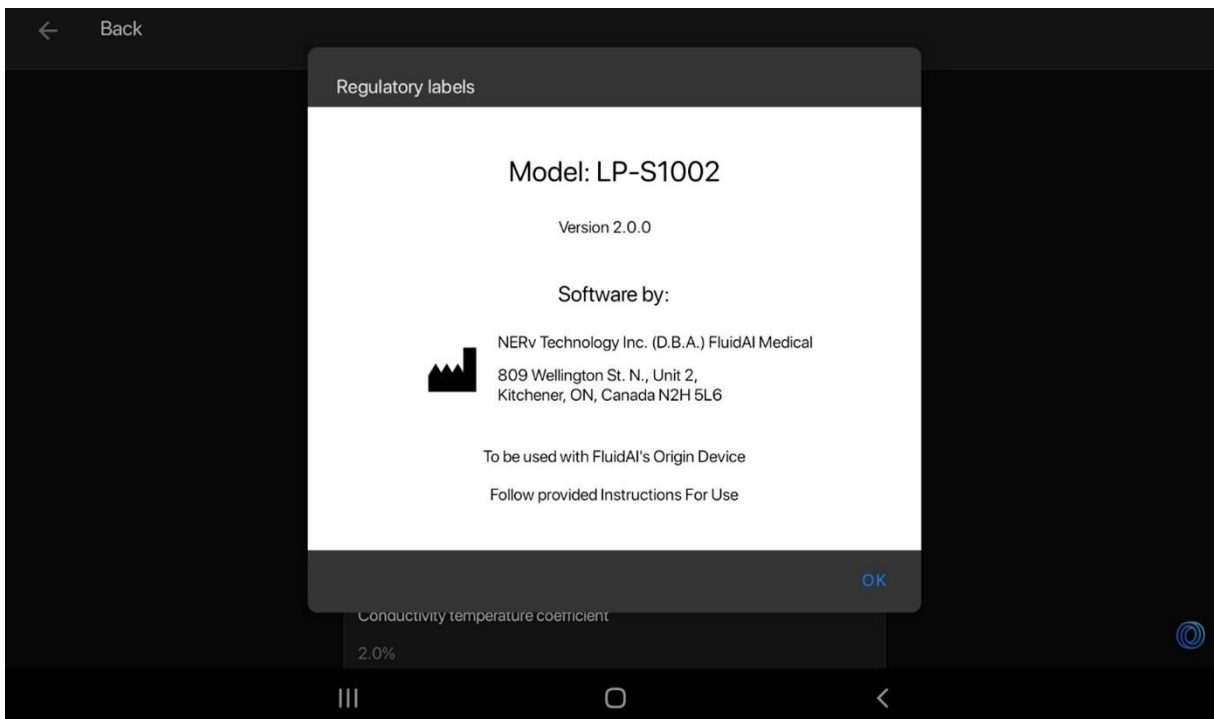

Figure 9: Regulatory Label on Stream™ App. Please refer to the label within the App for the most up-to-date version #.

4.9 Servicing

System servicing is restricted to *Stream™ App* software updates only. *Origin™* does not require any servicing as it is a single-use device. *Stream™* may require occasional software updates. Software updates will be done by qualified *FluidAI Medical* personnel and/or representatives.



NOTE

Stream™ is not user serviceable. Any attempts to do so by the user may render *Stream™* or *Origin™* unusable. Servicing can only be done by qualified *FluidAI Medical* personnel and/or representatives.

5 *Origin™* and *Stream™* Operation Instructions

This section will provide information and instructions for using *Origin™* and *Stream™ App*. It also provides information and instructions for device daily calibration.

5.1 *Stream™ App* Initial Setup

Step 1 – Unlock *FluidAI Medical*'s mobile device by entering the appropriate password.

Step 2 – Launch the *Stream™ App* by selecting the *Stream™* application icon on the mobile device provided by *FluidAI Medical*.



Figure 10: *Stream™* application icon

Step 3 – On the “Select Region” screen, select the appropriate region of operation to dictate the tablet’s regional settings. Press “📍 Save Region” to complete regional setup.

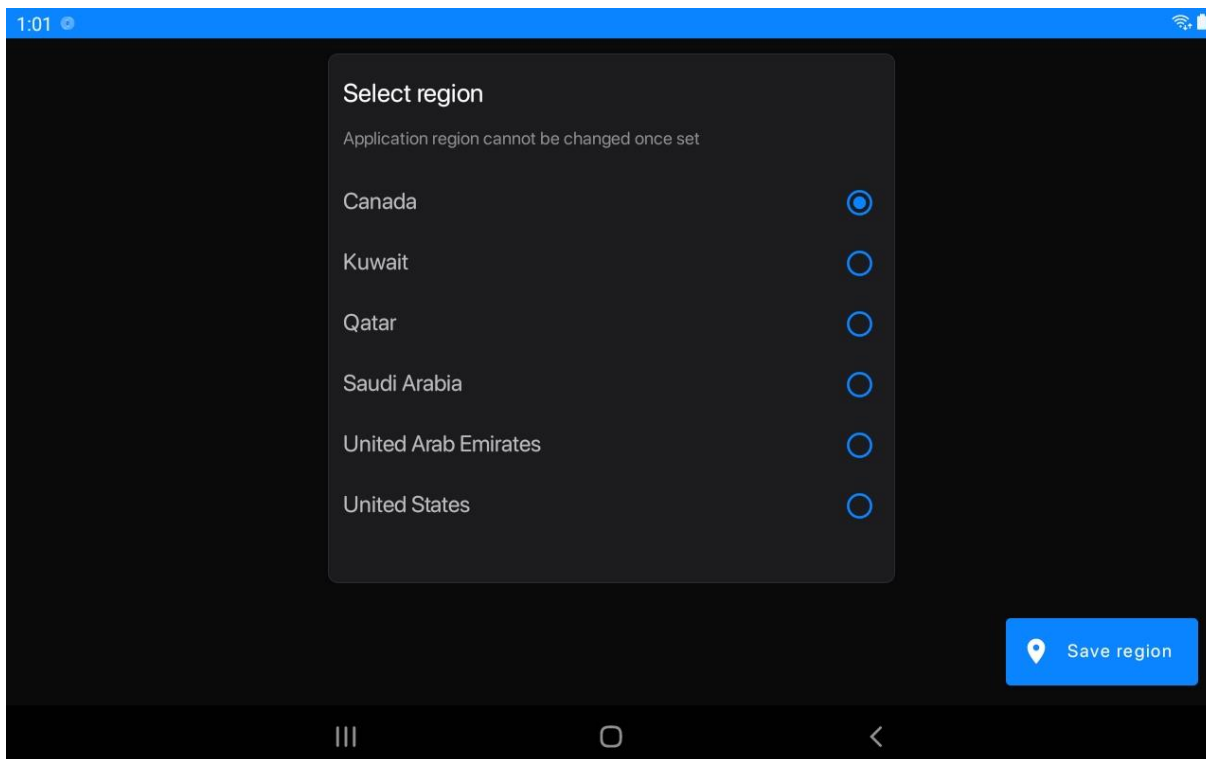

Figure 11: “Select Region” Screen

Step 4 – Stream™ will prompt you to confirm that the region you have entered is correct via a pop-up message. If the region is correct, press “Save Region” to proceed. If the region is incorrect, select “Change Region” to amend the regional information entered.

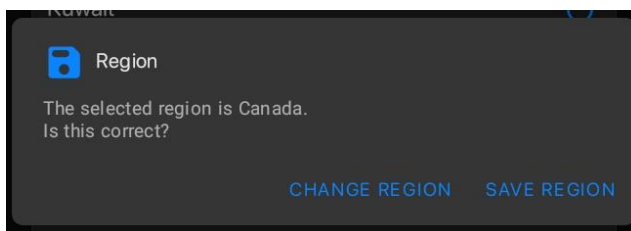

Figure 12: Confirm region pop-up message.

Step 5 – On the “Setup Organization” screen, enter your institution’s full name. A dropdown menu of organizations within your region will appear. If you cannot find your organization on the list, Stream™ will prompt you to add a new organization. Press “Save organization” to complete the setup process.

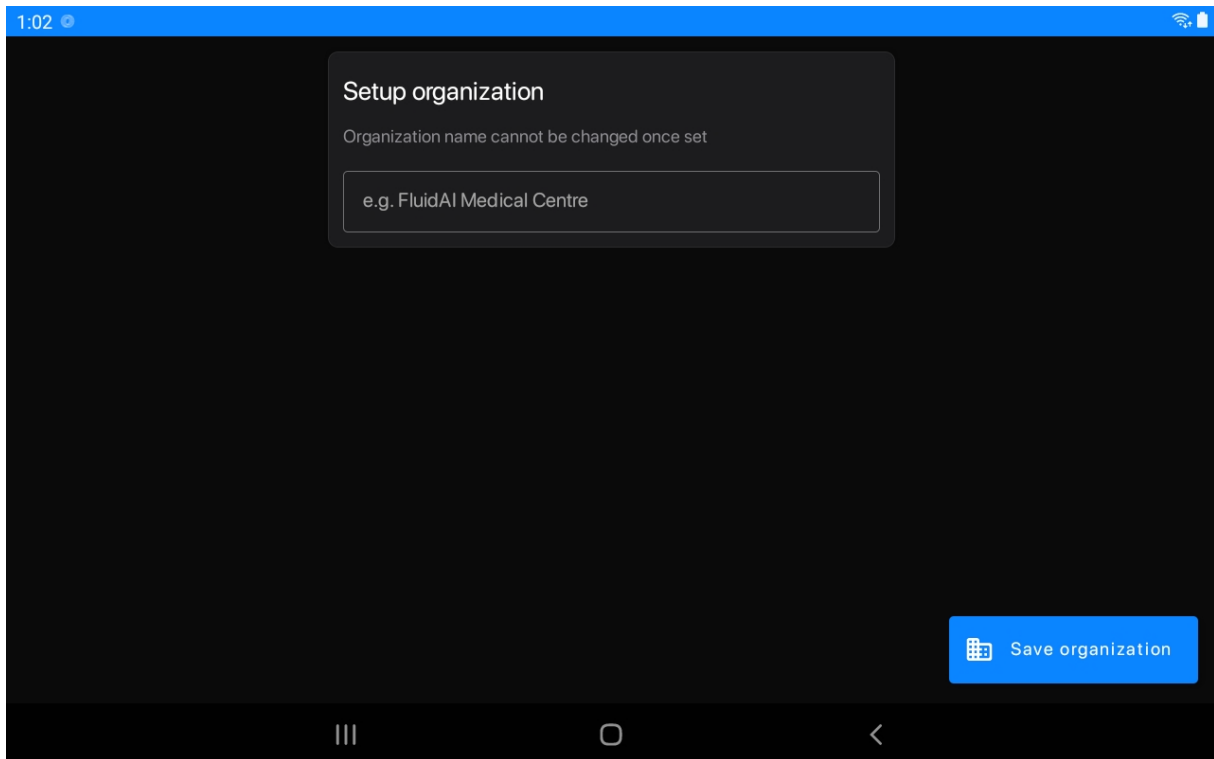

Figure 13: “Setup Organization” Screen

Step 6 – *Stream™* will prompt you to confirm that the organization name you have entered is correct via a pop-up message. If the organization name is correct, press “Save Organization” to proceed. If the organization name entered or chosen is incorrect, select “Change Region” to amend the organization name entered.

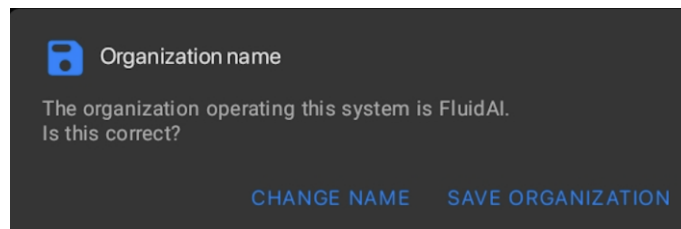

Figure 14: Confirm organization name pop-up message.

CAUTION!



Once set, the region and organization name cannot be modified. Please ensure that the region and organization names are both entered correctly for accurate time/date setup and for proper interpretation of sensor data.

5.2 Unpackaging of *Origin™*

Step 1 – Peel the plastic wrap away from *Origin™*'s packaging.

Step 2 – Unpack *Origin™* by slowly lifting the top lid off. A quick setup guide can be found on the inside of the top lid. This provides instructions on how to operate *Origin™* and how it can be attached to a patient’s closed drainage system.

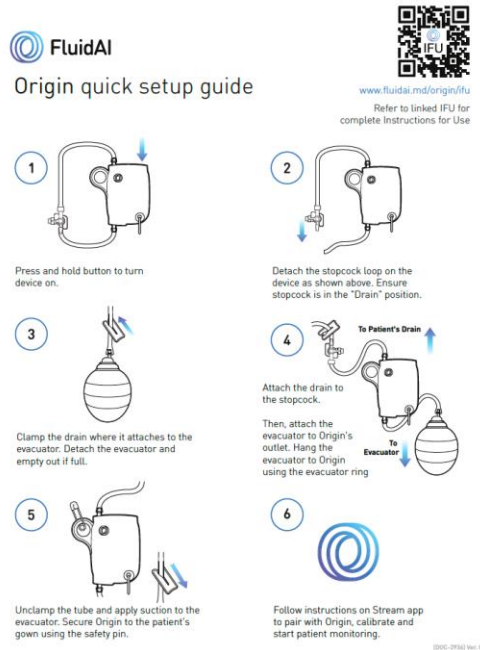

Figure 15: Quick guide instruction inside *Origin™*'s packaging

Step 3 – Lift the flap used to secure *Origin™* in place. Remove *Origin™* and associated accessories (tube clamp and 2” safety pin) from their packaging.

NOTE



The system’s packaging will include the following components: an *Origin™* inline device, a 120mm Silicone tube, an 85mm Silicone tube, a stopcock assembly, a 2” safety pin, and a tube clamp (depicted in Figure 1, and summarized in Table 1). Verify the contents of the package. In case of an incomplete package, contact *FluidAI Medical/* your local representative and do not use the system.

Step 4 – Dispose of packaging in accordance with hospital and local guidelines.

CAUTION!



Always check the packing of *Origin™* for damage before starting to unpack. Do not proceed to use the system in case of damage to the packaging.

5.3 Turning “ON” *Origin™* and Attachment of *Origin™* to the Patient’s Wound Drain

Step 1 – Perform hand hygiene before handling the drainage system and *Origin™*.

Step 2 – Don clean gloves.

Step 3 – Turn *Origin™* “ON” by pressing and holding the power button on the top of the device for three seconds.

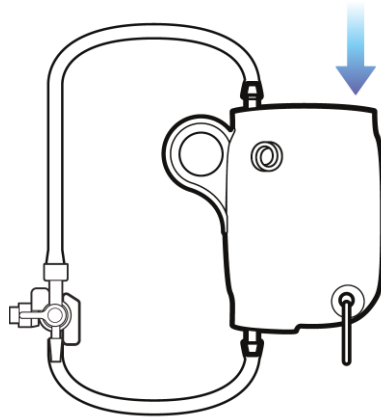

Figure 16: *Origin™* with multi-purpose button highlighted.

Step 4 – Place a waterproof pad (not provided by *FluidAI Medical*) on the bed beneath the evacuator and the patient’s wound drain.

Step 5 – *Origin™* will be packaged as illustrated in **Figure 17**. Detach the shorter portion of tubing from the tube adapter on the 3-way stopcock as dictated by the blue arrow. A label reading “Detach this tubing end” will be present to guide the user and indicate the end that must be detached from the 3-way stopcock.

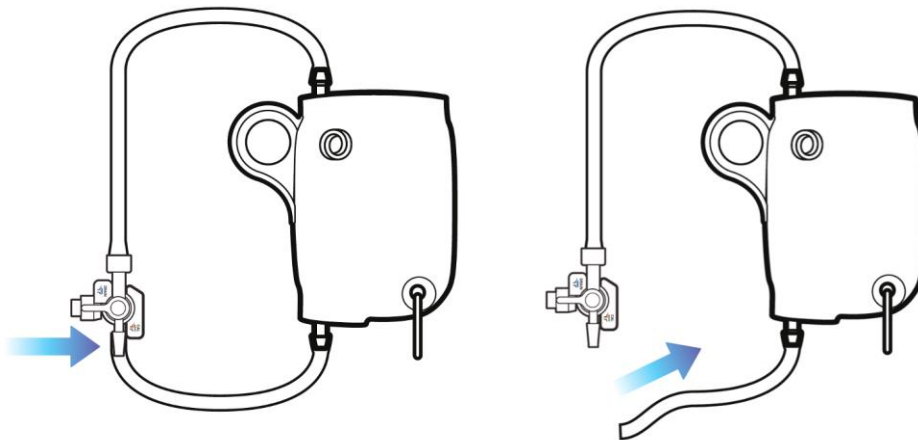

Figure 17: *Origin™* with associated flexible tubing and 3-way stopcock

WARNING!



- Do not detach the long tubing from the 3-way stopcock.

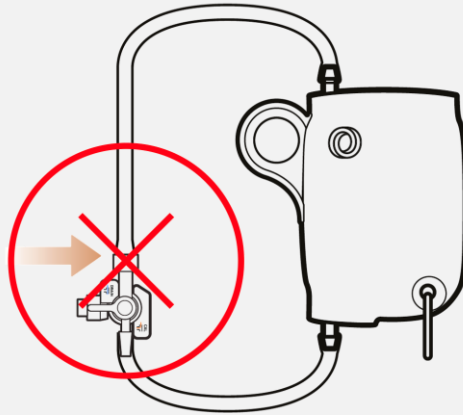

Figure 18: Incorrect detachment point of Origin™'s flexible tubing.

- **Do not invert the stopcock. Inversion of the stopcock can result in incorrect direction of flow of calibration fluid during calibration which can harm the patient.**

Step 6 – Use the tube clamp (packaged with Origin™) to clamp the flexible tubing and impede drainage into the evacuator as depicted by **Figure 19** below. Do not clamp the flexible tubing too close to the evacuator to facilitate the attachment of Origin™ to the patient's wound drain.

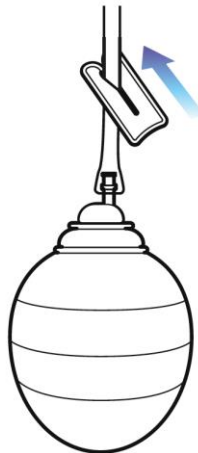

Figure 19: Occlusion of drainage in the closed wound drainage system

Step 7 – Empty the evacuator while following aseptic techniques as per standard protocol.

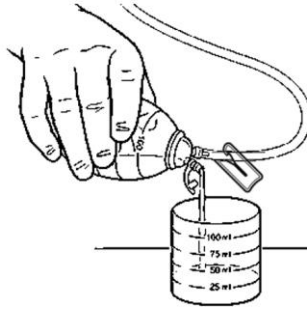

Figure 20: Emptying out the evacuator.

Step 7 – Maintaining asepsis, disconnect the flexible tubing of the wound drainage system from the evacuator.



Figure 21: Detaching the evacuator from the drain.

Step 8 – Use an alcohol swab (not provided by *FluidAI Medical*) to cleanse the one-way port on the evacuator and the short tube of *Origin™*. Connect the two by slowly sliding the port into the short flexible tubing of *Origin™*.

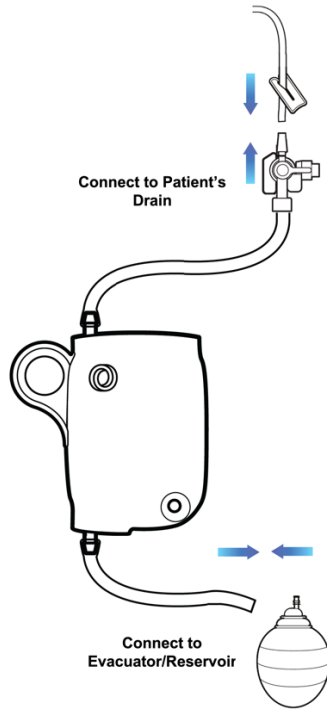

Figure 22: Schematic of how Origin™ connects to the patient's wound drainage system.

Step 9 – Use an alcohol swab to cleanse the tube adapter of the 3-way stopcock and the flexible tubing of the wound drainage system and connect the two by slowly sliding the tubing of the wound drainage system into the exposed port of the 3-way stopcock.

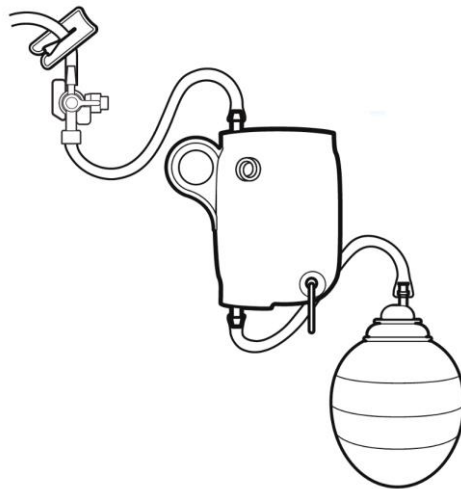

Figure 23: Schematic of Origin™ connected to the patient's wound drainage system.

Step 10 – Ensure that the “OFF” on the 3-way stopcock is directed towards the positive pressure cap/infusion port, i.e., in “DRAIN” position.

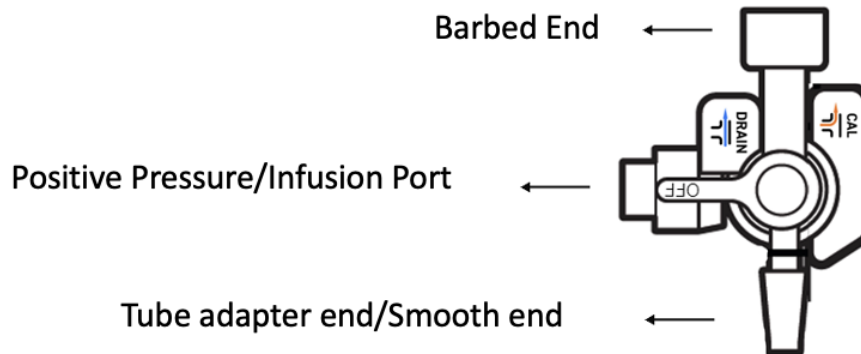

Figure 24: Stopcock orientation to facilitate drainage.

Step 11 – **Remove the tube clamp and apply suction to the evacuator as per standard practice.** To avoid accidental occlusion of the drainage system the tube clamp should be completely removed. *Optional:* After being removed, the tube clamp can be hung on the blue loop ring to be used during detachment of *Origin™*. Alternatively, the tube clamp can be disposed of as per the institution’s guideline.

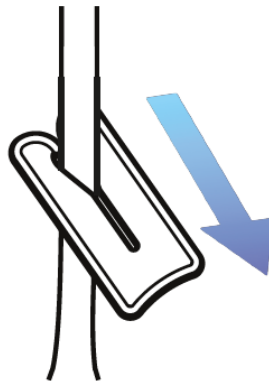

Figure 25: Tube clamp removal to re-establish drainage.

Step 12 – (Optional) Use the reservoir ring/evacuator ring to securely hang the evacuator to *Origin™*.

Step 13 – (Optional) Secure the evacuator and *Origin™* to the patient’s gown below the wound site using the safety pin provided as depicted by Figure 26 below. Ensure that the tubing is not pulled tight and there is room for the patient to move without creating tension on the tubing or dressing.

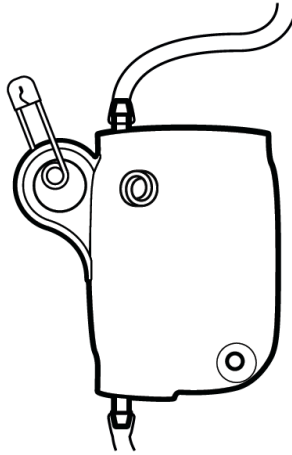

Figure 26: Origin™ with Safety pin

Step 14 – Ensure that there is no kinking in the system. Discard soiled supplies, remove gloves, and perform hand hygiene.

WARNING



- Improper orientation of the stopcock can impede drainage and result in harm to the patient. The “OFF” indicator must always be positioned towards the positive pressure cap/infusion port of the 3-way stopcock (i.e., in “DRAIN” position) except during calibration.
- Clots or large collections of debris may block the flow of drainage in the wound drainage system. These must be stripped/milked as per standard of care.

WARNING



- Clots or large collections of debris may obstruct flow within *Origin™*'s flow cell or between the outlet nozzle and the evacuator. These can be relieved via flushing with accessory calibration syringes.
- Expected outcomes include proper wound healing, patient comfort, proper wound drainage, the establishment of proper vacuum, patent tubing, and an intact suction system. If *Origin™* is influencing any of the above, the device must be removed/replaced as per **Section 5.8 – Disconnecting Origin™ from Patient's Wound Drain.**
- To minimize tension on the tubing or dressing, it is recommended that both *Origin™* and the evacuator be secured to the patient's gown specifically when the patient is mobilizing.
- **User must re-establish flow within the closed wound drainage system by removing the tube clamp after attachment of Origin™. Neglecting to do so can result in serious harm to the patient.**

NOTE

- *Origin™* has been designed to fit a wide variety of compatible wound drains as dictated in **Section 3.6 – Compatible Drainage Systems**.
- Always inspect the system to ensure that it is functioning properly. This includes confirming that drainage is flowing as expected through *Origin™* and tubing in the direction of the evacuator, inspection of the patency of the drainage tubing, inspection of the airtight connection sites, and inspection for the presence of any leaks or kinks in the system (See Figure 27).

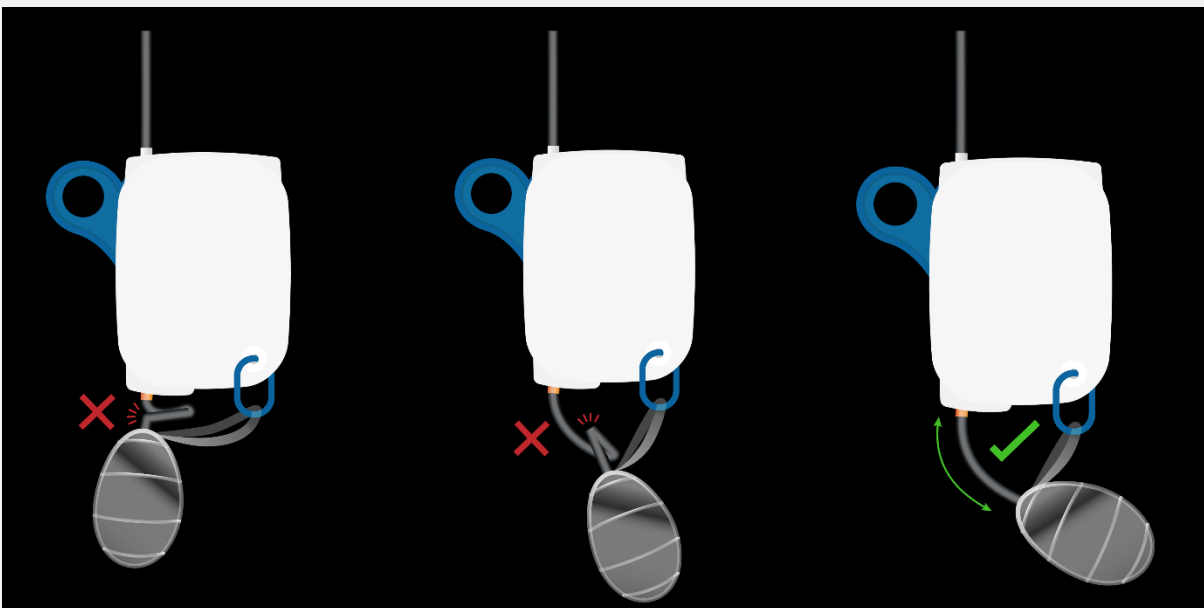

Figure 27: Improper vs. Proper tubing positioning to avoid kinking of flexible tube.

NOTE

- Abide by the healthcare institution's policy for follow-up care. Make sure to periodically observe the drainage and watch out for leakage.
- If the patient has multiple wound drains, it is recommended that multiple *Origin™* devices be used.
- A maximum of 4 *Origin™* devices can be paired to an individual patient on *Stream™*.
- **The service life of *Origin™* is up to 10 days after initial operation (or until drain is removed/patient is discharged, whichever sooner). Performance of *Origin™* may degrade after the 10-day period. It is recommended that a new *Origin™* be used if the patient must be monitored for longer than 10 days.**
- *Origin™* is only indicated for use by healthcare professionals (as dictated by Section 3.4). Patients cannot be discharged or sent home with *Origin™*.

5.4 Creation of Patient Record on *Stream™* App

Step 1 – Launch the *Stream™* App by selecting “Stream” on FluidAI Medical’s mobile device.

Step 2 – Select the “+ Add patient” button on the dashboard screen of the application.

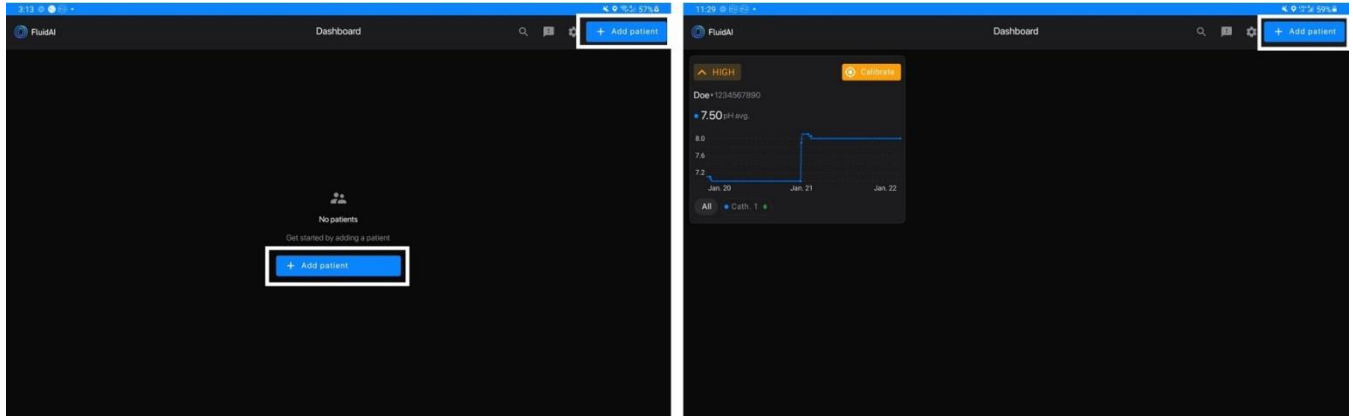

Figure 28: Dashboard/main screen with “+Add Patient” button.

Step 3 – *Stream™* will prompt you to input the patient’s information.

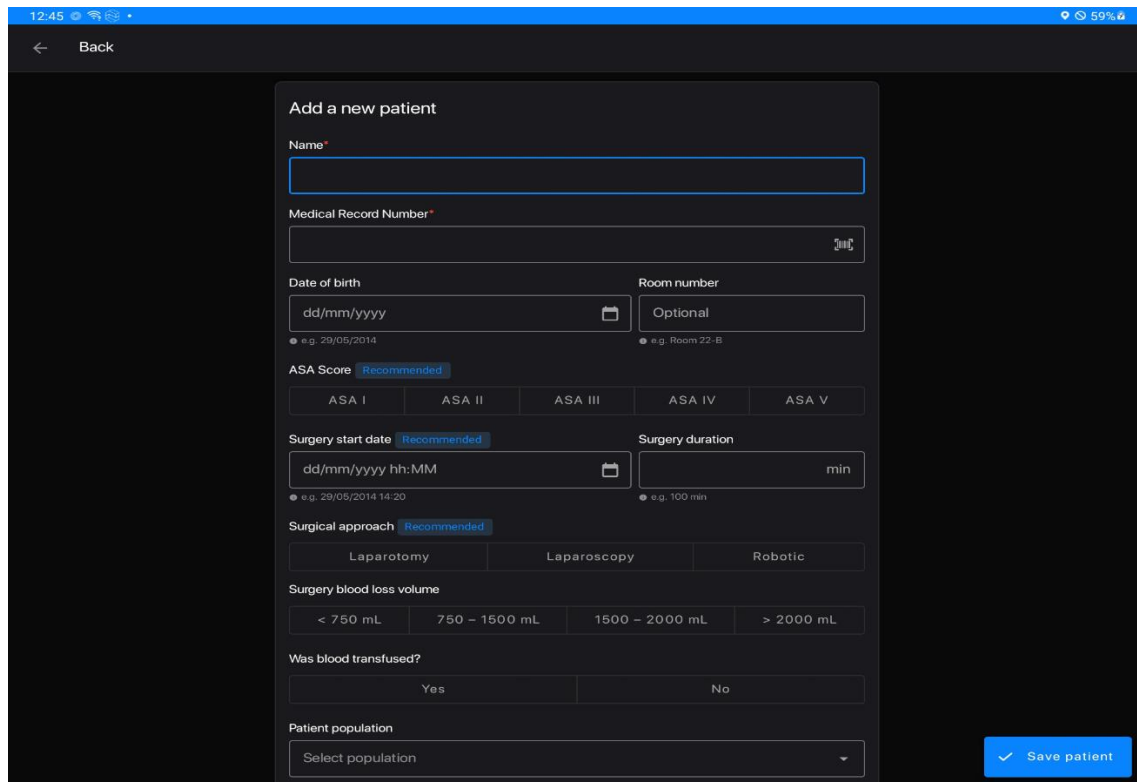

Figure 29: “Add a New Patient” Information Screen

Patient Information Includes:

- Required Information to create the patient record
 - Patient Name
 - Medical Record Number (MRN)
- Recommended Information (Required to calculate leak risk)
 - ASA Score (calculated pre-operatively)
 - Surgery start date and time (dd/mm/yyyy hh:MM)
 - Surgery duration (min)
 - Surgical approach
- Optional Fields:
 - Date of Birth (dd/mm/yyyy)
 - Location of Patient (for example: room number, unit, bed number, etc.)
 - Blood Transfusion
 - Surgery blood loss volume
 - Patient Population

Additional optional patient information may be required to calculate Leak Risk as updates become available.



NOTE

- Mandatory fields required for the creation of a patient record on *Stream™ App* will be marked by a red asterisk.
- *Stream™* will not allow the user to proceed to the next screen without inputting the patient’s name and MRN.
- All fields that are labelled recommended, such as surgery *start date*, surgery time, *ASA Score*, *Surgical Approach*, and surgery duration, are required to calculate the patient *Leak Risk* (See Section **Error! Reference source not found.**). Inaccurate inputs can lead to an incorrect *leak risk* calculation.
- (Optional) The user can choose to select the “” button to the right of the Medical Record Number field to scan the patient’s medical ID bracelet instead of manually entering the patient’s MRN number.



NOTE

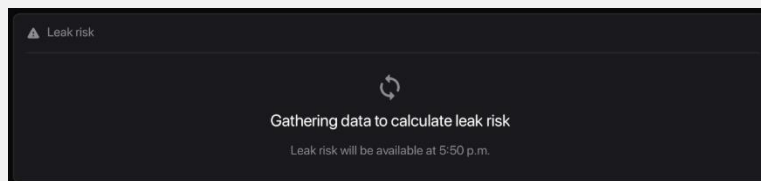

Figure 30: Information not provided for Leak Risk Calculation

- If the user inputs the surgery start date and time, *Stream™* will assume that the user is interested in calculating a *leak risk* and will not allow them to proceed with creating the patient record without completing the surgery duration field.

- If the user inputs the surgery duration, *Stream™* will assume that the user is interested in calculating a *leak risk* and will not allow them to proceed with creating the patient record without completing the surgery start date and time field.
- If the user inputs the surgical approach, *Stream™* will assume that the user is interested in calculating a *leak risk* and will not allow them to proceed with creating the patient record without completing the surgery start date, surgery time, and surgery duration fields.
- If **any** of the recommended fields (ASA score, surgery *start date* and time, surgery duration and/or surgical approach) are modified, the *leak risk* calculation will reset and previously calculated *leak risk* for the patient will be lost.

Step 4 – Create a new patient record by selecting the “✓ Save Patient” button.

Step 5 – *Stream™* will prompt you to verify that the information you have entered is correct. Make sure to review the patient information. If correct, press “✓ Confirm” to proceed. Select “✎ Edit patient” to amend the information entered.

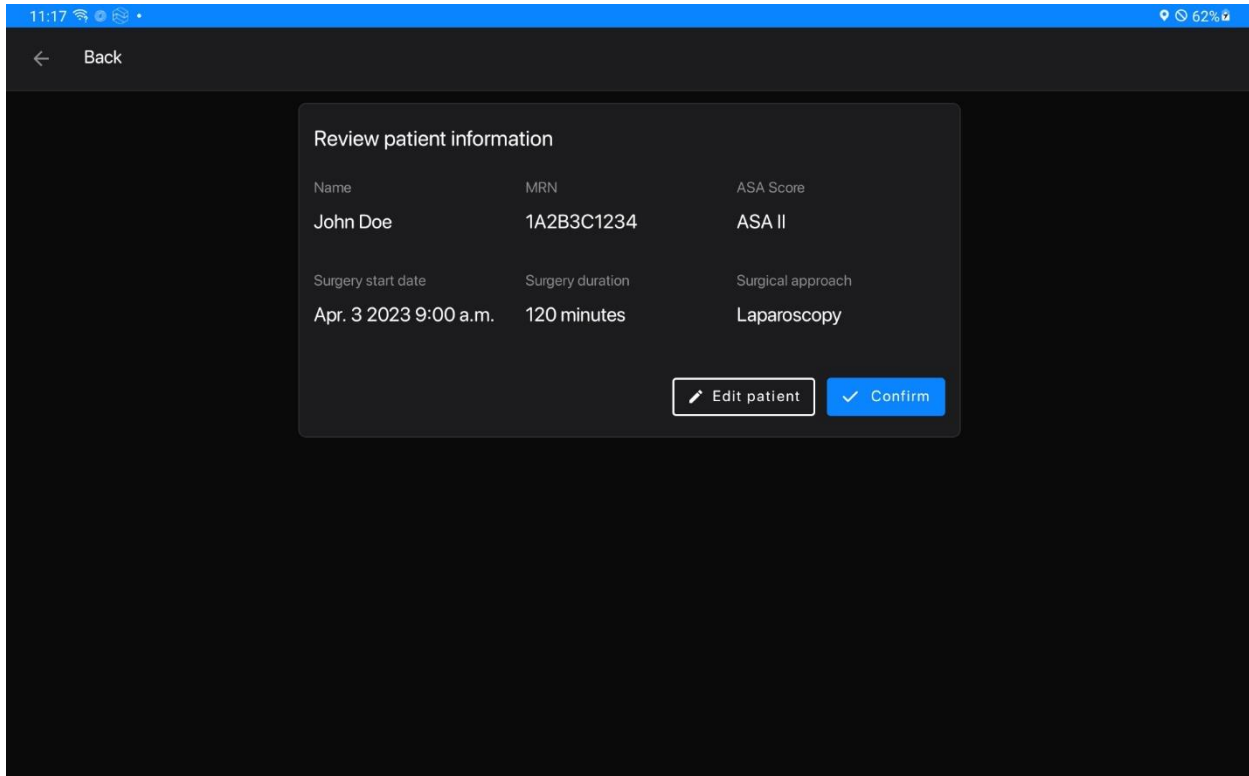

11:17 62%

← Back

Review patient information

Name	MRN	ASA Score
John Doe	1A2B3C1234	ASA II
Surgery start date	Surgery duration	Surgical approach
Apr. 3 2023 9:00 a.m.	120 minutes	Laparoscopy

Figure 31: Review Patient Information Screen



NOTE

- Patient information can be modified later by selecting the dropdown menu “:” on the patient card and selecting edit patient.
- User can delete the patient record at any time by selecting the dropdown menu “:” on the patient card and selecting delete patient.
- A pop-up message will indicate that the edits made to the patient record have been successfully saved on the *Stream™ App*

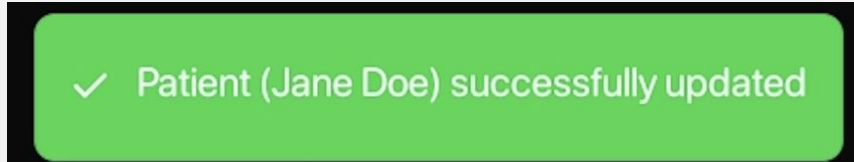

Figure 32: Edits made by the user have been successfully saved on *Stream™*

Step 6 – A pop-up message will appear to indicate that a patient record has been successfully created on *Stream™*. Select “View Patient” to directly go to the patient monitoring screen. Select “OK” to return to *Stream™ App*’s dashboard screen. Select “Link Device” to proceed to pairing of *Origin™* to *Stream™*.

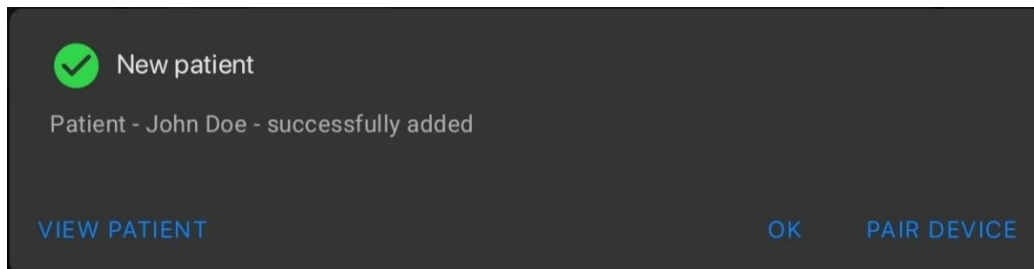

Figure 33: Prompt showing the successful creation of a new patient record on *Stream™*

5.5 Pairing *Origin™* to the *Stream™ App*

Step 1 – To enter pairing mode on *Stream™*, perform any of the following steps:

- **METHOD 1:** Upon successful creation of a new patient record on *Stream*. A pop-up message will appear. To proceed with device pairing, select “PAIR DEVICE” on the successful patient creation prompt.
- **METHOD 2:** On the dashboard/main screen, select the “✳ Pair device to patient” button on the patient card that you want to pair *Origin™* to.
- **METHOD 3:** On the dashboard/main screen, select the patient card that you want to pair *Origin™* to. Select the “✳ Pair device to patient” button located in the center of the patient monitoring screen or on the bottom left corner of the screen.

- METHOD 4: Select the dropdown menu “:” on the patient card on the dashboard screen. Choose “* Pair Device” from the dropdown menu to proceed with pairing of *Origin™*.
- METHOD 5: On the dashboard screen, select the patient card that you want to pair *Origin™* to. Select the dropdown menu “:” associated with the patient information. Choose “* Pair Device” from the dropdown menu to proceed with pairing of *Origin™*.

METHOD 1

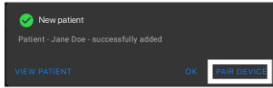

METHOD 2

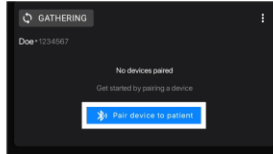

METHOD 3

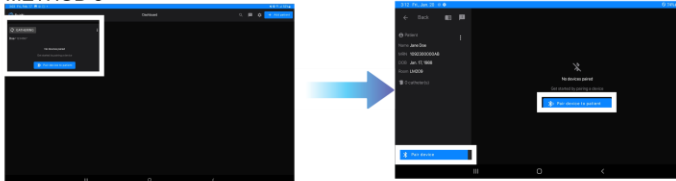

METHOD 4

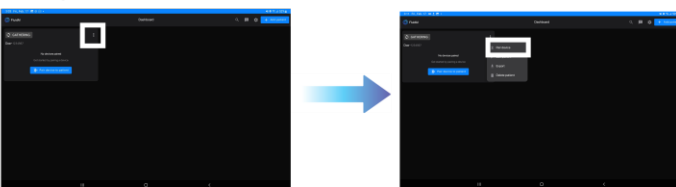

METHOD 5

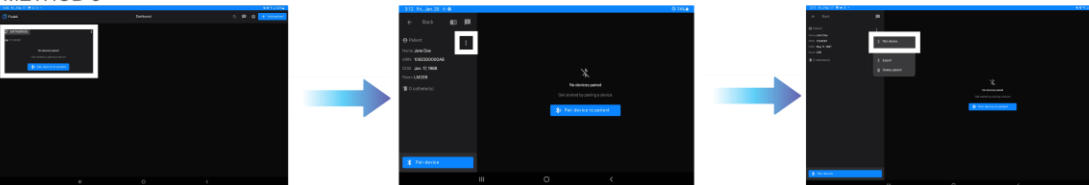

Figure 34: Stream™ App screens showing the “Pair Device” button.

Step 2 – On the pairing screen, you will be prompted to pair *Origin™* to *Stream™* via Bluetooth pairing or by scanning the QR code at the back of *Origin™*. A list of nearby operational *Origin™* device(s) will appear on the device pairing screen (**Figure 35**). Select the appropriate device serial number that will be paired to the respective patient.

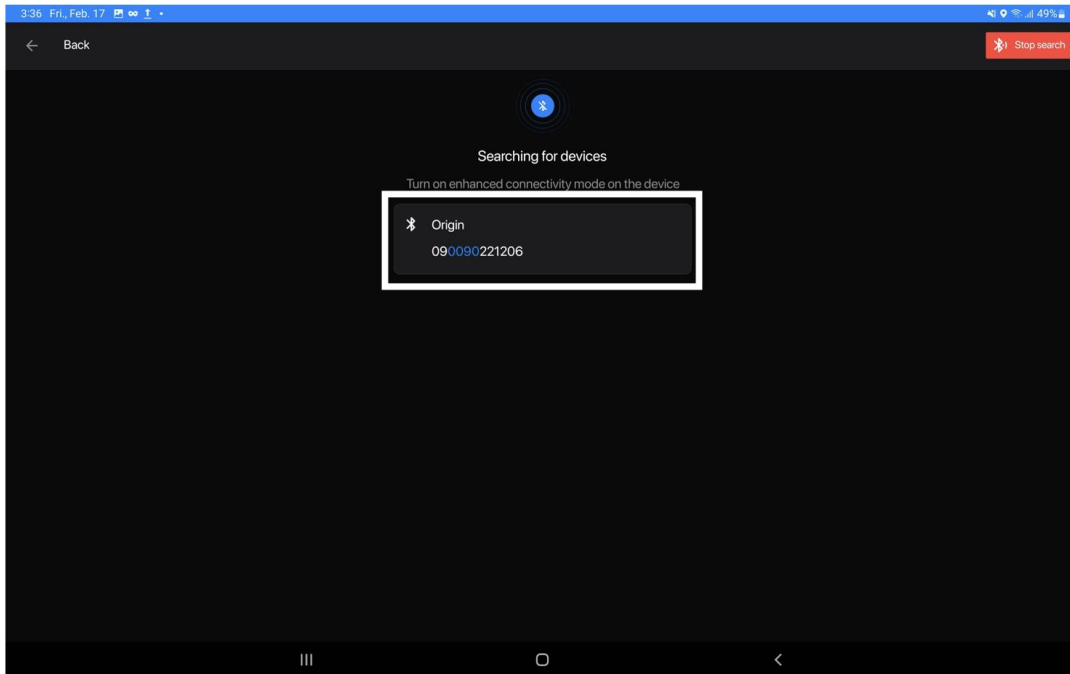

Figure 35: Device Pairing Screen – Bluetooth

Step 3 – Alternatively, point the tablet’s camera at the QR code on the back panel of the device for automatic pairing.

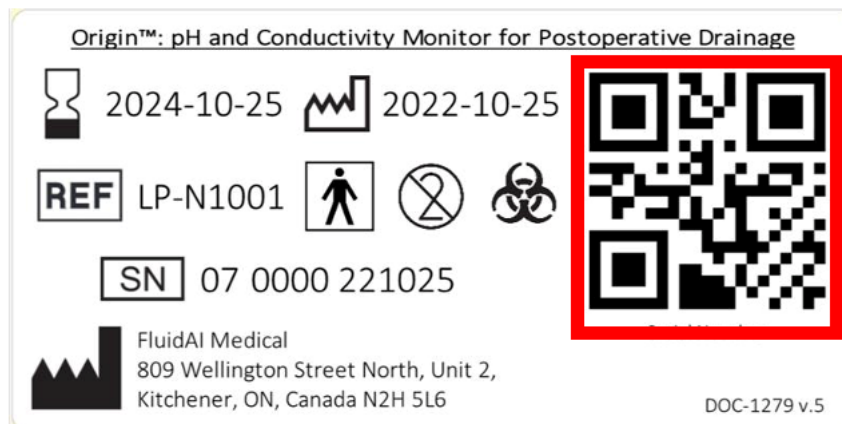

Figure 36: Origin™ label with QR code highlighted.



NOTE

- Ensure that the *Origin™* is turned on (Section 5.3) before proceeding with pairing.
- The serial number of *Origin™* (label on the back) should match the serial number shown on the *Stream™ App* device pairing screen.
- Patients with multiple wound drainage systems may require multiple devices.
- **A maximum number of five *Origin™* devices can be paired to a single mobile device.**

Step 4 – (Optional) *Stream™* will prompt you to label the catheter to which the *Origin™* device will be attached to. If the patient has multiple drains, you can assign a label to the respective drains as per your institution’s guidelines (example: Right/Left, 1/2/3/4, or RUQ/LUQ/LLQ/RLQ/Pelvic). A default catheter ID of 1 will be assigned by *Stream™*. A maximum of 10 characters can be inputted for the catheter ID. Press “Continue →” to complete pairing.

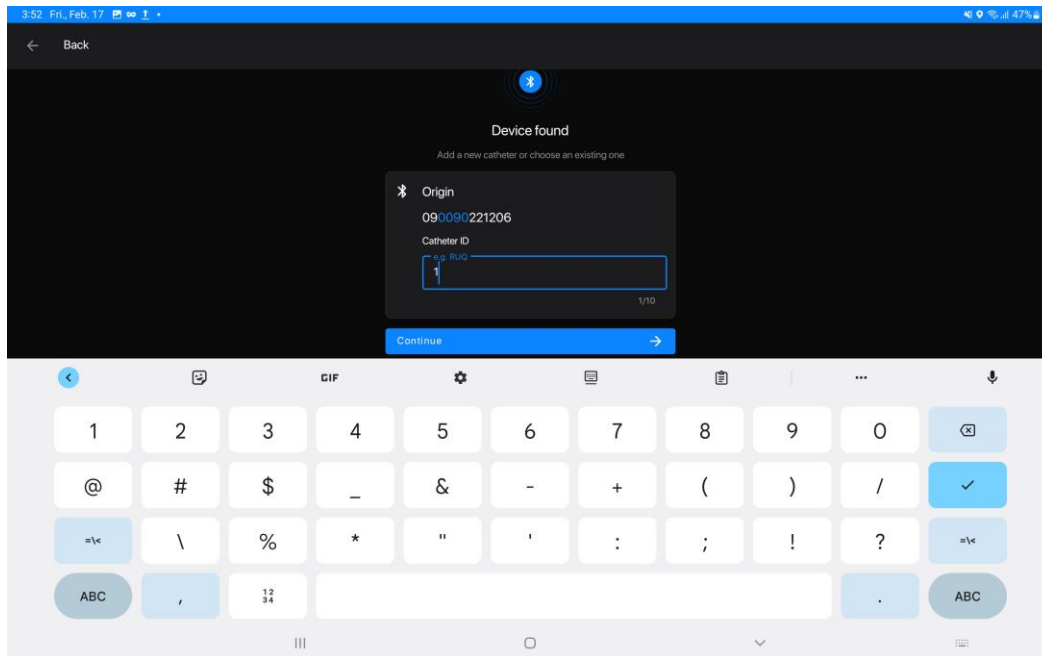

Figure 37: User Assigned Catheter ID Label

Step 5 – A prompt will appear to indicate successful pairing of *Origin™* to the respective patient record on *Stream™*. Select “Ok” to return to the patient monitoring screen or proceed to initial calibration by selecting “Calibrate Device”.

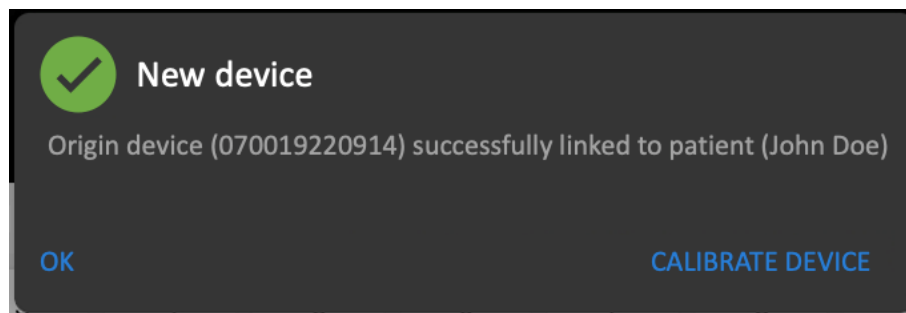

Figure 38: Prompt showing successful pairing of *Origin™* to *Stream™*



NOTE

- If you attempt to pair an *Origin™* inline device to the same patient twice, *Stream™* will display the following pop-up.

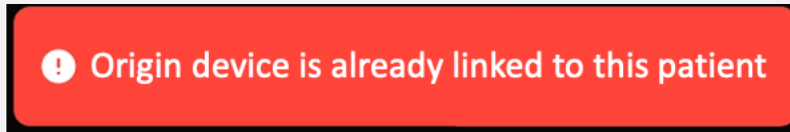

Figure 39: Error message indicating that *Origin™* has already been paired to this patient.

- *Origin™* is a single-use disposable device. If *Stream™* detects that *Origin™* has already been paired to another patient record, device pairing will be blocked.

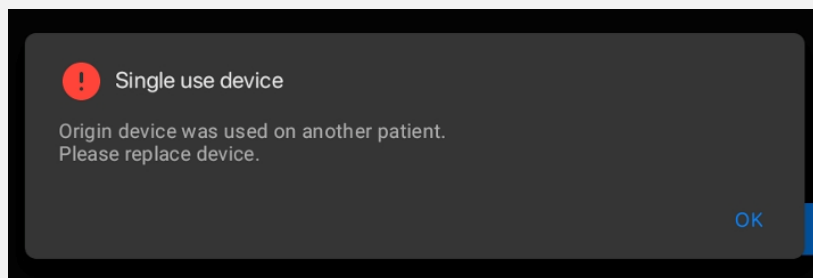

Figure 40: Error message indicating that *Origin™* has been previously paired to another patient record

5.6 Calibration of *Origin™*

Origin™ requires periodic calibrations to ensure that it delivers accurate measurements of pH and Electrical Conductivity. Calibration is essential for optimal performance of *Origin™* and correct *Leak Risk* calculation.

Origin™ must be calibrated at the following times:

- After initial attachment of *Origin™* to the patient's drain system.
- Every 24 hours (at minimum) thereafter: The **minimum** number of calibrations required is once every 24 hours (*Stream™* application will prompt for recalibration).

FluidAI Medical provides users with calibration syringes (packaged separately). These are to be used to conduct daily calibrations of *Origin™* sensors. An individual syringe pack contains three (3) syringes that will be used to conduct a single calibration.

Calibration syringes are pre-filled with NIST-traceable calibration fluids (pH buffer and conductivity standard) which need to be injected by the user into *Origin™*'s flow cell. The positive pressure cap/infusion port on the 3-way stopcock will be used to facilitate the calibration process. The user will be prompted by *Stream™* to flush the flow cell with the appropriate calibration fluid to ensure the accuracy of the process.



CAUTION!

Calibrations are necessary to receive accurate pH and conductivity measurements. *Leak Risk* calculated for devices that have not been calibrated will not be accurate. Avoid the use of the device if calibration is past due.

The calibration steps for *Origin™* are outlined below. The calibration process will be initiated by the *Stream™ App*. Visual guides and reminders will be shown on *Stream™* to help guide the user. When a device is due for calibration (i.e., upon initial attachment to the wound drain or if 24 hours have passed since the previous calibration), an orange calibrate icon will be seen at the respective patient’s card on the dashboard/main screen and on the catheter card on the patient monitoring screen.



Figure 41: Calibrate Icon on Stream™

Upon selection of the catheter card, a **calibration overdue alert** will appear if *Origin™* is overdue for calibration. Select “Cancel” to ignore the alert. Select “Calibrate” to proceed with calibration.



Figure 42: Calibration Overdue Alert



WARNING!

- Aseptic technique must be followed with all calibration procedures. Always don clean gloves when handling the device and the drainage system.

5.7 Preparation for Calibration

Step 1 – Obtain the accessory syringe pack from the designated storage space. (Optional): User may need to empty the evacuator if it is full prior to or after calibration, a specimen/measuring cup (not provided by *FluidAI Medical*) may be required.

Step 2 – Confirm that the calibration pack has not expired by inspecting the label. Ensure that the seal is intact.

CAUTION!



- Do not use a calibration pack if it is past its expiry date or if the package seal has been broken or shows evidence of tampering.
- Verify that the syringes are still capped and are not leaking. Do not use the pack if one or more fluids or syringe caps are missing or if the pack shows evidence of fluid leaks.

Step 3 – Open the calibration pack and verify that the following three (3) syringes are included:

- Flushing solution (Clear Syringe)
- Calibration solution 1 (Red Syringe)
- Calibration solution 2 (Blue Syringe)

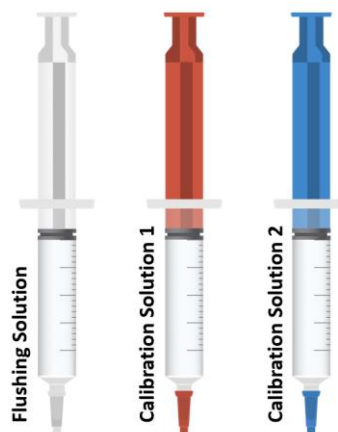

Figure 43: Accessory Calibration Syringe Pack

Step 4 – *Stream™ App* will be used to guide the user through calibration. Confirm that the correct *FluidAI Medical's* mobile device with the respective patient's record (and associated *Origin™*) is being used.

Step 5 – Ensure that *FluidAI Medical's* mobile device has at least 50% charge or is connected to a charger.

NOTE



- If the *Stream™ App* or *FluidAI Medical's* mobile device crashes/shuts off during a calibration, turn it back on and restart the calibration process.

Step 6 – Before calibrating, empty the evacuator. Conduct standard practice measures including assessing drain fluid (type, volume, color, etc.) before starting the calibration procedure, as applicable. Note that these characteristics may change as a result of calibration since calibration

fluids will be emptied into the evacuator. Re-establish suction in the evacuator before commencing the calibration process.



CAUTION

- Calibration will introduce fluids into the evacuator that may change the volume and color of the existing wound drainage.
- If wound drainage is required to be collected as a specimen for laboratory assessment, the user must **collect the specimen before** conducting the calibration of *Origin™*. Calibration fluid can affect the composition of the wound drainage.
- Always perform hand hygiene before and after handling the drainage system and *Origin™*.
- Do not leave the evacuator cap open during the calibration process to prevent the spillage of calibration fluid on the patient’s bed or gown. Re-establish suction as per standard protocol before commencing the calibration process.

5.8 Calibration Procedure

Step 1 – Check to see if a patient’s device is due for calibration by looking for the “Calibrate” button on *Stream™*’s dashboard/main screen.

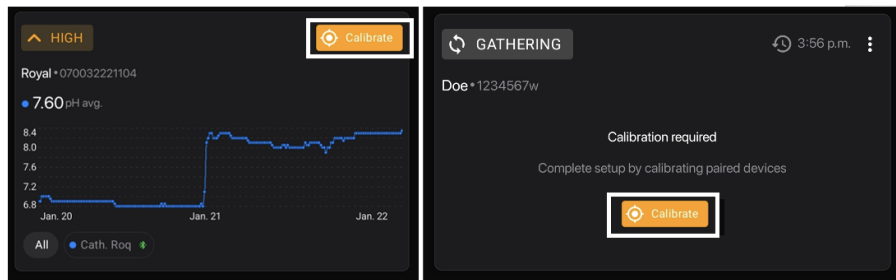

Figure 44: Patient Card on *Stream™*’s Dashboard screen with “Calibrate” Button



NOTE

- If a patient has multiple *Origin™* devices, all devices must be calibrated using multiple and different sets of the calibration syringe packs.
- If a patient has multiple *Origin™* devices, verify the correct device is being calibrated by matching the serial number on the *Origin™* label and the serial number displayed on the *Stream™* App before proceeding. Alternatively, use the user defined catheter ID to confirm that the correct device is being calibrated.

Step 2 – To enter calibration mode on *Stream™ App*, perform any of the following steps:

- **METHOD 1:** After an *Origin™* is successfully paired with *Stream™*, a dialogue box will prompt you to proceed with calibration. Choose “Calibrate” to commence the calibration process. You can also select the catheter card on the patient monitoring screen. The *Stream™ App* will prompt you to calibrate via a pop-up message. Choose “Calibrate” to proceed with calibration.
- **METHOD 2:** Select the “⊕ Calibrate” button on the patient card on *Stream’s™* dashboard/main screen. This will direct you to the patient monitoring screen. *Origin™* devices that are due for calibration will have a “⊕ Calibrate” button associated with them. Select the “⊕ Calibrate” to commence the calibration process.
- **METHOD 3:** Select the patient card to enter the patient monitoring screen. Use the dropdown menu on the catheter card “:” to select “⊕ Calibrate” and enter calibration mode on *Stream™*.

NOTE



Method 3 above may be used to calibrate the *Origin™* inline device if, for example calibration reminder fails to show and/or if the mobile device crashes. Please refer to **Section 5.14** for instructions on how to send feedback/file a bug.

METHOD 1

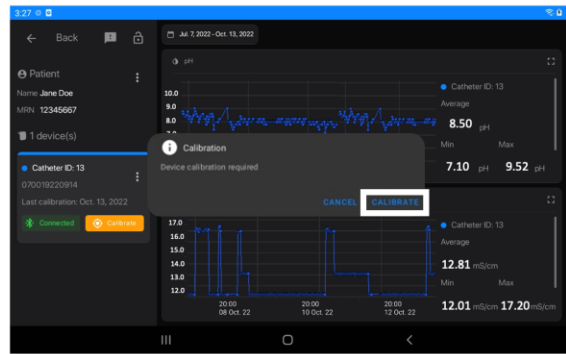
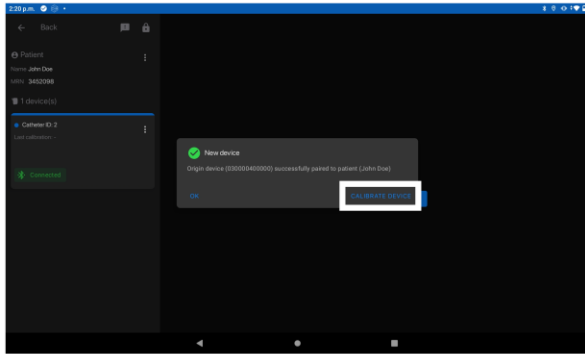

METHOD 2

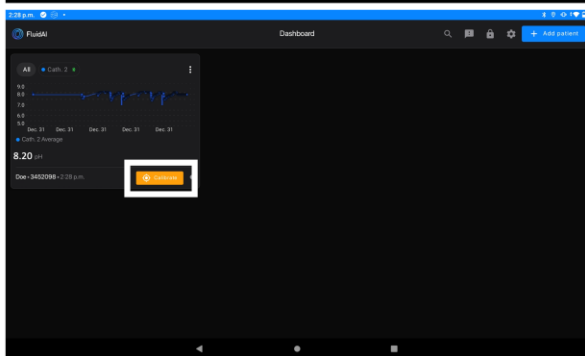
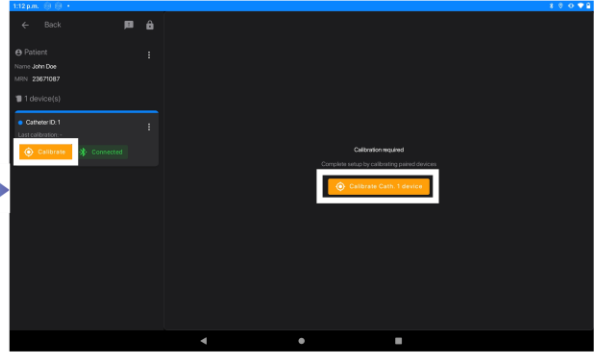
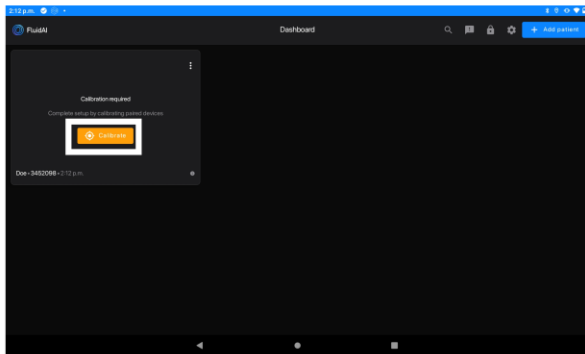

METHOD 3

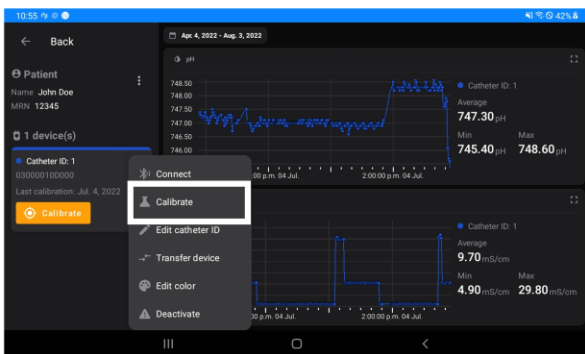

Figure 45: Stream™ App screens showing the “CALIBRATE” button.

Step 3 – IMPORTANT: Rotate the stopcock such that the “OFF” indicator is turned to “CAL” (or pointing towards the patient/patient’s wound drain). This will allow for flow between the calibration syringe and *Origin™*. (Optional) User can also use the tube clamp to obscure the patient’s wound drain prior to calibration.



Figure 46: 3-way Stopcock adjusted for Calibration.



WARNING

- Inversion of the stopcock accessory by incorrectly attaching *Origin™* to the patient’s drain may result in the flow of calibration fluid into the wound drain which may harm the patient.
- Failure to rotate the stopcock and application of pressure may cause the syringe to eject from the infusion port. **Rotate the stopcock before** starting the calibration process.

Initial Flush Using Clear Syringe

Step 4 – Remove the protective Luer lock cover (cap) on the Luer lock (tip) end of the **clear syringe**. Remove any air bubbles by inverting and tapping the syringe, letting the air bubbles rise, and then slowly pushing the plunger to remove them.

Step 5 – Use an alcohol swab (not provided by *FluidAI Medical*) to clean the positive pressure cap/infusion port on the 3-way stopcock (*see Figure 24*) and the Luer lock end of the clear syringe.

Step 6 – IMPORTANT: Ensure that there is no kinking in the system (long and short flexible tubing).

Step 7 – Attach the white Luer lock (tip) syringe by twisting the syringe onto the positive pressure cap/infusion port of the 3-way stopcock.



NOTE

Ensure that the syringe is securely locked into the port before proceeding.

Step 8 –With an even and gentle pressure, depress the plunger using a turbulent stop-start technique to inject the fluid from the calibration syringe into the stopcock/catheter. Minimal resistance should be felt. Ensure that the injected fluid is being drained into the evacuator. Fluid should flow through and saturate the flow cell of *Origin™*. Flush using the entire contents of the syringe.

**WARNING!**

- **Do not use excessive force when depressing the syringe plunger.** If the plunger does not smoothly depress, check for the following:
 - 1) Ensure that the orientation of the stopcock is correct (i.e., the stopcock is in “CAL” mode).
 - 2) Ensure that there is no kinking in *Origin™*'s short flexible tubing. If kinking is observed, the system must be unkinked prior to commencing calibration. Failure to do so can result in device malfunction (See Figure 27).
 - 3) Ensure that there is no kinking in *Origin™*'s long flexible tubing. If kinking is observed, the system must be unkinked prior to commencing calibration. Failure to do so can result in device malfunction (See Figure 27).
 - 4) Ensure that there is no clear clots or large collections of debris obstructing flow at the stopcock. If clear obstruction is seen at the stopcock attempt to strip/milk the drain as per standard of care. If obstruction persists clots or large collections of debris can be relieved by performing a flush using the accessory calibration syringes. Closely monitor *Origin™* afterwards to ensure that it is functioning properly. If any malfunction is observed the system must be replaced immediately.
 - 5) Ensure that there is no clear clots or large collections of debris obstructing flow at the evacuator/bulb. If clear obstruction is seen at the evacuator/bulb attempt to strip/milk the drain as per standard of care. If obstruction persists clots or large collections of debris can be relieved by performing a flush using the accessory calibration syringes. Closely monitor *Origin™* afterwards to ensure that it is functioning properly. If any malfunction is observed, the system must be replaced immediately.
 - 6) Ensure that there is no clear clots or large collections of debris obstructing flow within the device flow cell or at *Origin™*'s inlet/outlet nozzles. If clear obstruction is seen, attempt to strip/milk the drain as per standard of care. If obstruction persists, clots or large collections of debris can be relieved by performing a flush using the accessory calibration syringes. Closely monitor *Origin™* afterwards to ensure that it is functioning properly. If any malfunction is observed, the system must be replaced immediately.
- Depressing the plunger forcefully can result in the leakage of fluid into *Origin™*'s internal module which will lead to electrical damage and may impair device function. This may also result in a fire or shock.
- If the plunger was depressed forcefully despite feeling resistance, usage of the device must be stopped immediately, and the device must be replaced.



WARNING!

- Stream™ will show a clear animation of what the system should look like during calibration.
- During calibration on Stream™, an “**i**” icon at the top right corner will guide users through how to troubleshoot the system in case resistance is felt.

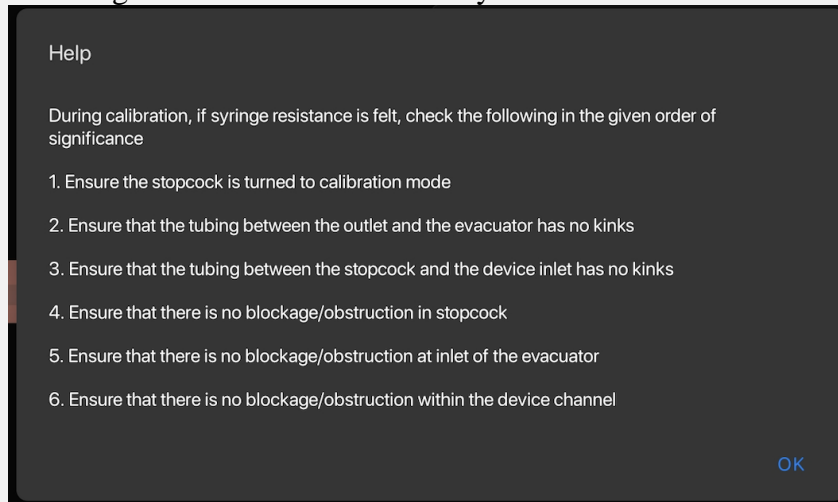

Figure 47: Help Guide to troubleshoot resistance felt during calibration.



Figure 48: Clear Syringe inserted in the infusion port with the stopcock “OFF” towards the patient.

Step 9 – Carefully remove the white syringe from the positive pressure cap/infusion port of the 3-way stopcock.

Step 10 – Select “continue” on the *Stream™* application screen.

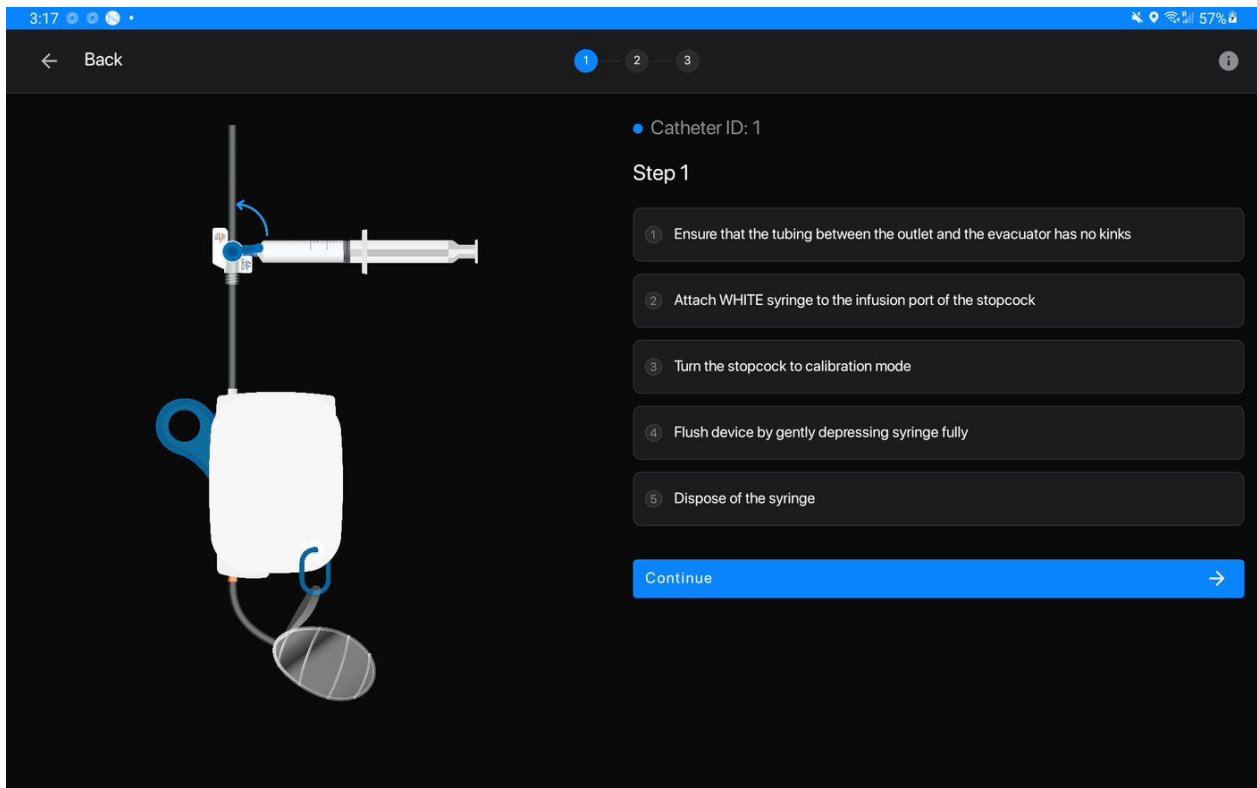

Figure 49: Instruction for conducting a flush using the clear syringe on *Stream™*

Step 11 – Reattach the cap to the empty syringe and place it back into the pack.

Step 12 – Wipe the top of the infusion port with an alcohol swab to remove fluid residue.



NOTE

- An animation will be seen on *Stream™* to guide users through the calibration process. The calibration steps will also be summarized on *Stream™ App* screen. The user must follow these instructions to ensure successful calibration.

Calibration of the Electrical Conductivity Sensor Using the Red Syringe

Step 13 – Remove the protective Luer lock cover (cap) on the Luer lock end (tip) of the **red syringe**. Remove any air bubbles by inverting and tapping the syringe, letting the air bubbles rise, and then slowly pushing the plunger to remove them.

Step 14 – Attach the red Luer lock syringe by twisting the syringe onto the positive pressure cap/infusion port of the 3-way stopcock (see **Figure 24**).

Step 15 – Ensure that the “OFF” indicator is directed towards the patient.

**NOTE**

Ensure that the syringe is securely locked into the port before proceeding.

Step 16 – With an even and gentle pressure, depress the plunger using a turbulent stop-start technique to inject the fluid from the calibration syringe into the stopcock/catheter. Ensure that the injected fluid is being drained into the evacuator. Fluid should flow through and saturate the flow cell of *Origin™*. Flush using the entire contents of the syringe.

**WARNING!**

Do not use excessive force when depressing the syringe plunger. Depressing the plunger forcefully can result in the leakage of fluid into *Origin™*'s internal module which will lead to electrical damage and may impair device function. This may also result in a fire or shock.



Figure 50: Red syringe inserted in the infusion port with the stopcock “OFF” towards the patient.

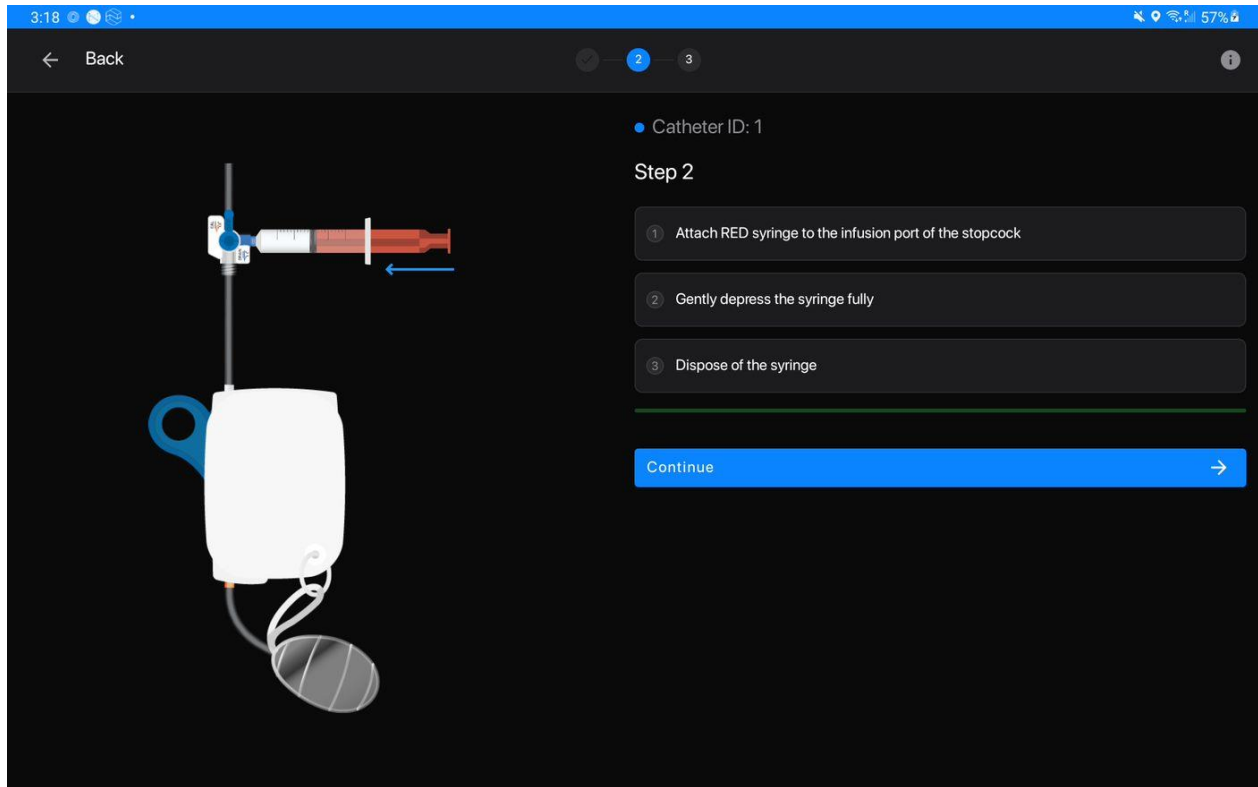

Figure 51: Instruction for EC sensor calibration using the red syringe on Stream™ application.

Step 17 – Press Continue. *Stream™* will now calibrate the electrical conductivity sensor. Successful calibration of the sensor will be indicated by an auditory prompt and automatic screen change.



NOTE

- After pressing continue, a green progress bar and a flashing “*Calibrating...*” label will show the progression of the electrical conductivity calibration step. Unsuccessful calibration of the sensor will result in a prompt being displayed. *Stream™* will provide clear instruction to resolve calibration errors. If errors persist, contact your local *FluidAI Medical* representative team for assistance if calibration fails.

Step 18 – Carefully remove the red syringe from the positive pressure cap/infusion port of the 3-way stopcock.

Step 19 – Reattach the cap to the empty red syringe and place it back into the pack.

Step 20 – Wipe the top of the infusion port with an alcohol swab to remove fluid residue.

Step 21 – Select “continue” on Stream™.

Calibration of the pH Sensor Using the Blue Syringe

Step 22 – Remove the protective Luer lock cover (cap) on the Luer lock end (tip) of the **blue syringe**. Remove any air bubbles by inverting and tapping the syringe, letting the air bubbles rise, and then slowly pushing the plunger to remove them.

Step 23 – Attach the blue Luer lock syringe by twisting the syringe onto the positive pressure cap/infusion port of the 3-way stopcock (see **Figure 24**).



NOTE

Ensure that the syringe is securely locked into the port before proceeding.

Step 24 – Ensure that the “OFF” indicator is directed towards the patient.

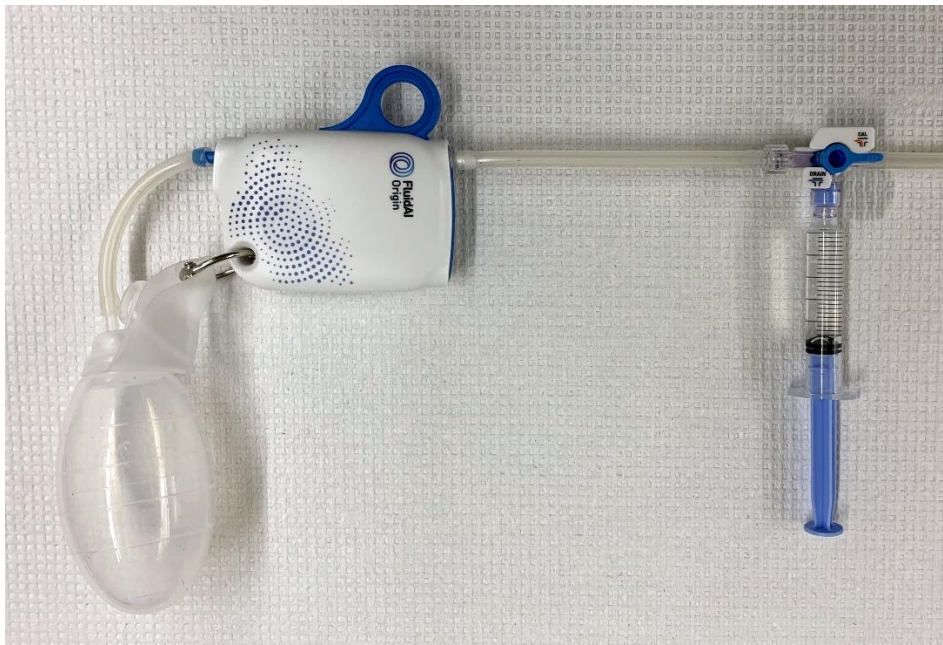

Figure 52: Blue syringe inserted in the infusion port with the stopcock “OFF” towards the patient.

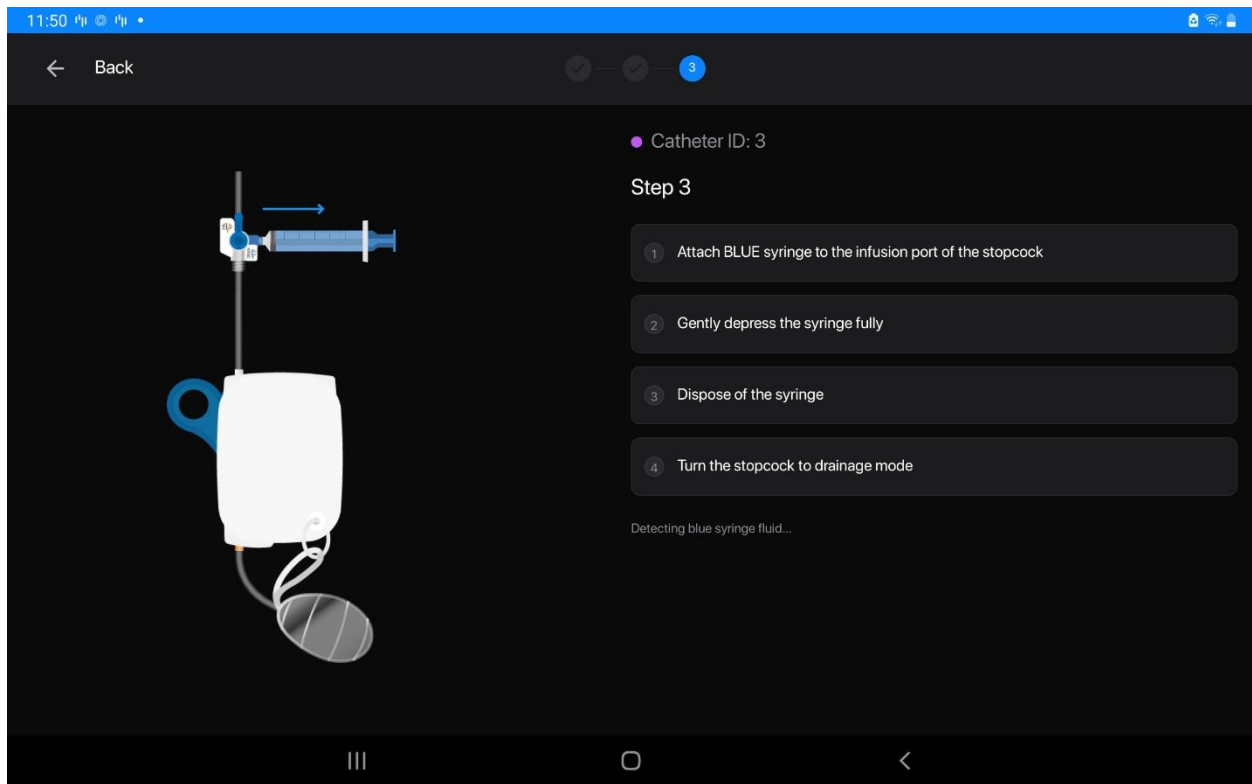

Figure 53: Instruction for pH sensor calibration using the blue syringe on Stream™

Step 25 – With an even and gentle pressure, depress the plunger to inject the fluid from the blue calibration syringe into the catheter. Ensure that the injected fluid is being drained into the evacuator. Fluid should flow through and saturate the flow cell of *Origin™*. Flush using the entire contents of the syringe.



CAUTION

Do not use excessive force when depressing the syringe plunger. Depressing the plunger forcefully can result in the leakage of fluid into *Origin™*'s internal module which will lead to electrical damage and may impair device function. This may also result in a fire or shock.



NOTE

Stream™ will attempt to automatically detect the pH calibration fluid. If the user takes too long before injecting the fluid, or if the wrong fluid is inserted, a “⚠️Waiting for BLUE syringe fluid” message will be displayed. If the error message is displayed, ensure that the correct syringe is being used.

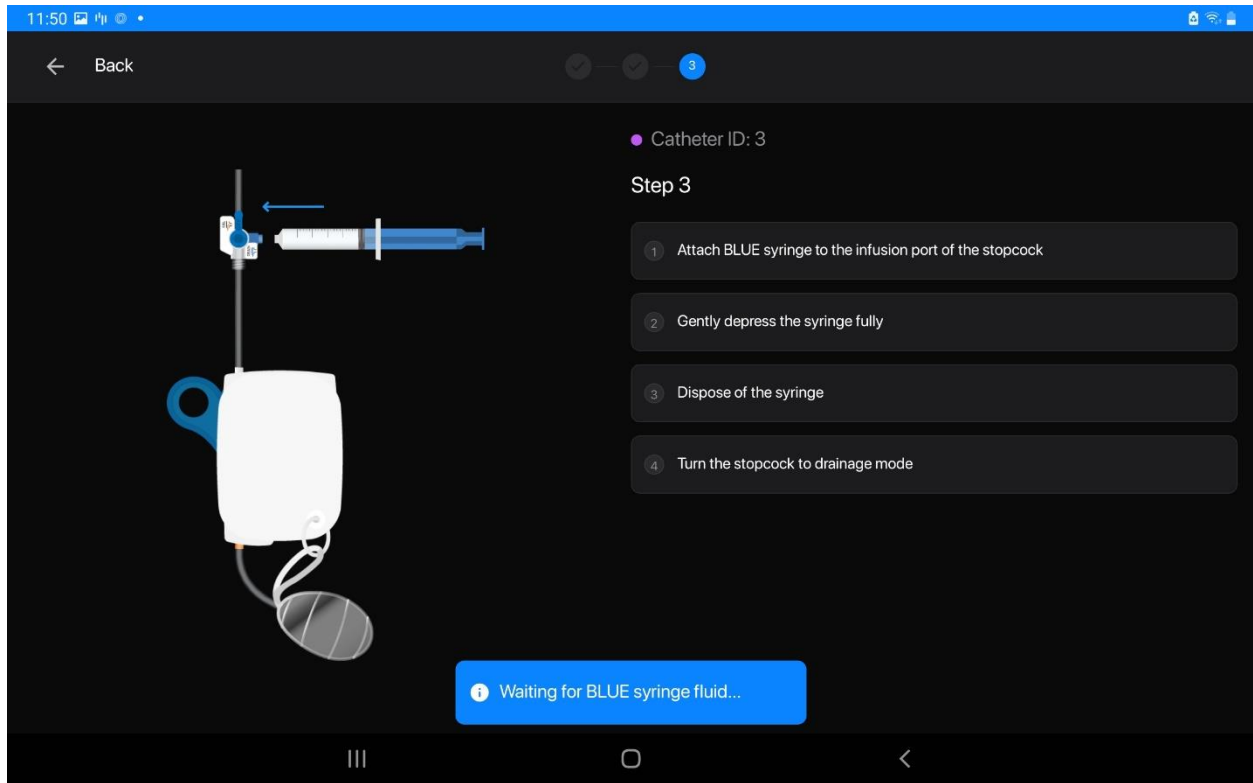

Figure 54: pH sensor calibration prompt

Step 26 – Stream™ will now calibrate the pH sensor as indicated by the appearance of the green calibration progress bar. Successful calibration of the sensor will be indicated by an auditory prompt and a pop-up message appearing.



NOTE

A “Successful calibration” pop-up message will appear if the calibration was conducted successfully, and the orange calibrate icon will disappear from the catheter card.

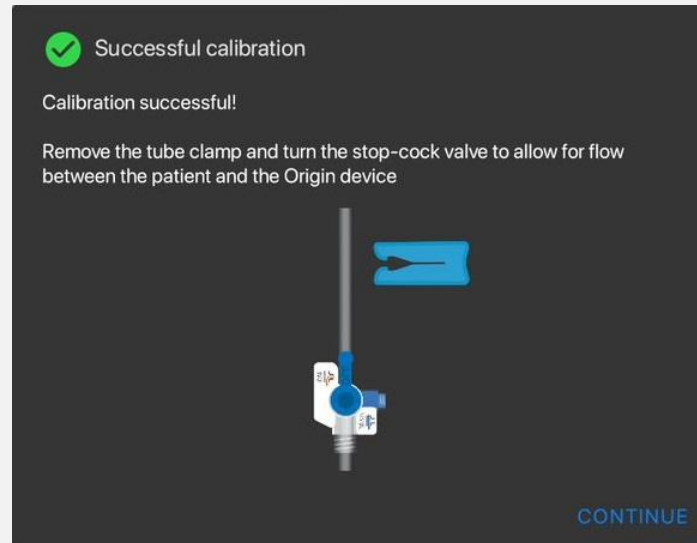

Figure 55: calibration successfully completed.

- If an error occurs during calibration, consult the troubleshooting guide in **Section 8 - Troubleshooting and Error Messages** or contact your local *FluidAI Medical* representative team.
- **User must re-establish flow within the closed wound drainage system by removing the tube clamp (if used) and returning the 3-way stopcock to “DRAIN” mode. Neglecting to do so can result in serious harm to the patient.**

Step 27 – Carefully remove the blue syringe from the positive pressure cap/infusion port of the 3-way stopcock.

Step 28 – Reattach the cap to the empty blue syringe and place it back into the pack.

Step 29 – Wipe the top of the positive pressure cap with an alcohol swab to remove fluid residue.

Step 30 – Empty the evacuator (to discard all calibration fluid) while following aseptic techniques as per standard protocol.

Step 31 – IMPORTANT: Rotate the stopcock such that the “OFF” indicator is rotated to the “DRAIN” position (pointing towards the positive pressure cap/infusion port of the 3-way stopcock).

**WARNING**

- Failure to turn the stopcock back to its original position will result in obstruction of the wound drainage system.



Figure 56: Stopcock “OFF” towards the positive pressure cap/infusion port/ DRAIN position.

Step 32 – Maintaining asepsis, re-establish suction in evacuator of the wound drainage system.

Step 33 – (Optional) secure the drainage system and *Origin™* below the wound site to the patient’s gown using a safety pin. The reservoir ring can be used to hold the evacuator.

Step 34 – Discard all soiled supplies and dispose of the used calibration syringes in accordance with hospital and local guidelines.

Step 35 – Remove gloves and perform hand hygiene.

**NOTE**

- *Origin™* is now calibrated and will begin giving continuous measurements for the next 24 hours.
- Conductivity and pH measurements may be inaccurate for up to 30 minutes following calibrations.

5.9 Anastomotic Leak Risk Category Feature

After the first successful calibration, *Stream™* will begin calculating the patient’s *Leak Risk* (See Table 5 under Section 3.10) using *Origin™*’s continuous measurements.

Conductivity and pH measurements may be inaccurate for up to 30 minutes following calibration. Therefore, *Stream™* will require time to calculate the *Leak Risk* (approximately 1 hour of non-erroneous measurements within POH 24) and will display a “*Gathering data to calculate patient leak risk*” message until enough measurements become available to compute the patient’s *Leak Risk*. The approximate time required to display the *Leak Risk* will also be portrayed on the patient’s monitoring screen. This will also depend on the flow rate of drained effusion.

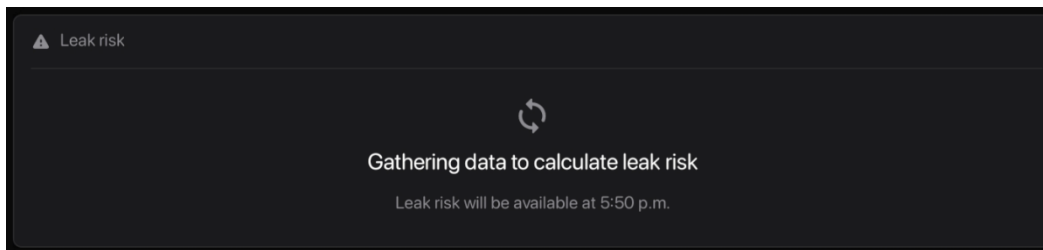

Figure 57: Initial Leak Risk is being Calculated.

Stream™ may also display a “*Surgery date required to calculate leak risk*” message. The ASA score, surgery start date, surgery time, surgery duration, and surgical approach are required to properly calculate the patient’s *Leak Risk*. Inaccurate user entry can result in an inaccurate calculated *Leak Risk*. Additional user input of other surgery/patient parameters may be required as *Leak Risk* feature updates become available. This information can be added by editing the patient information (See Section 5.4).



WARNING

The *Leak Risk* is **not a diagnostic or predictive tool**, it is intended as an indication to promote earlier diagnostic testing, as per the standard of care, for higher risk patients.

The hourly *Leak Risk* is displayed in Figure 58 below. A dialogue box at the bottom-right gives the current patient *leak risk*. Patients with a high/very high *Leak Risk* may require further diagnostic imaging as per standard of care.

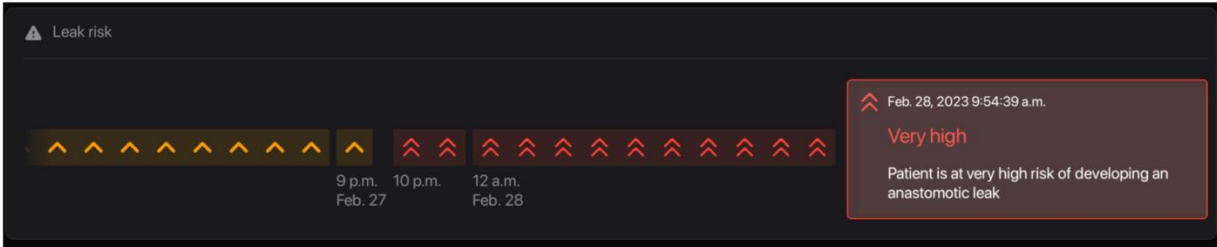

Figure 58: Leak risk section in Stream™ App

5.10 Over the Air (OTA) updates

After the first successful calibration, *Stream™* will check *Origin™*'s firmware. If a newer version is available, *Stream™* will update the firmware.

Update found: If a newer firmware version was found, *Stream™* will show a dialog box indicating the specific device that is undergoing a firmware update.

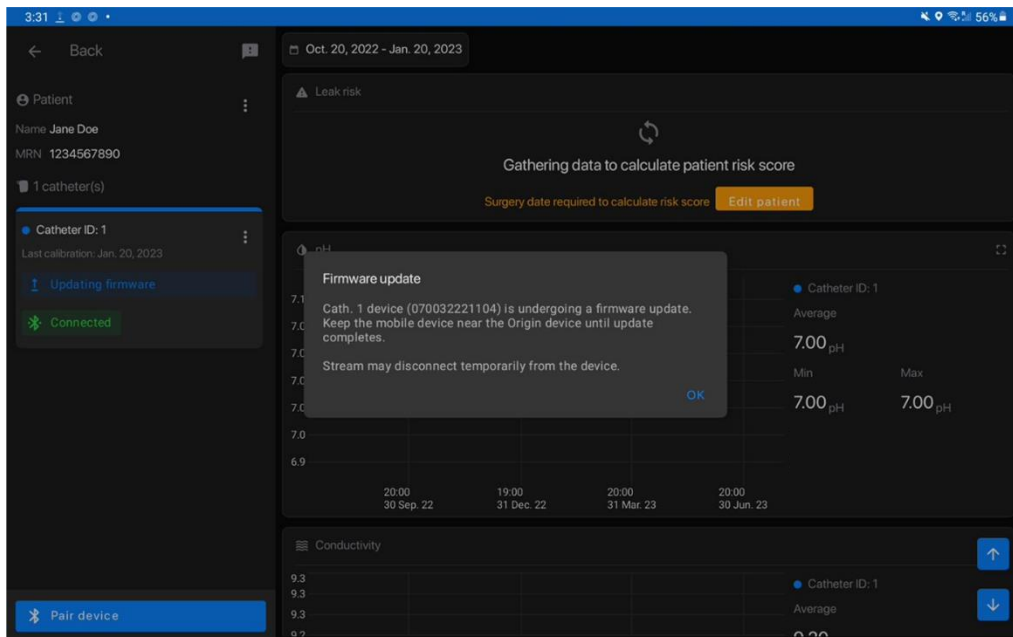

Figure 59: Dialog box showing that the specified Origin™ device is starting a Firmware update.

Update starts: *Stream™* will then start the firmware update and show “*Updating firmware*” on the catheter card, and the Yellow LED on *Origin™* will turn to solid Blue

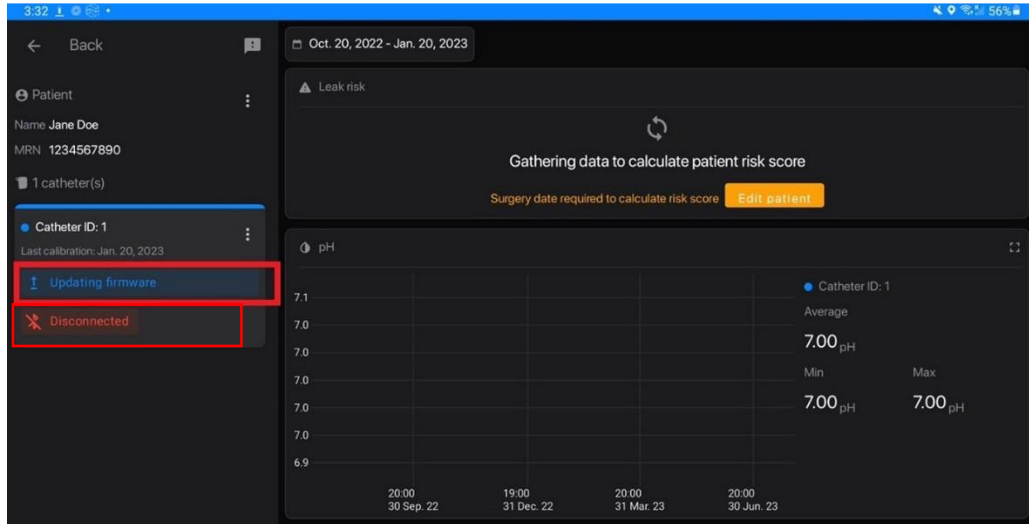

Figure 60: Stream™ screen showing that the Origin™ device is undergoing a firmware update.

Update complete: Once the update is complete, Origin™ will reconnect and Stream™ will show that the update was successful.

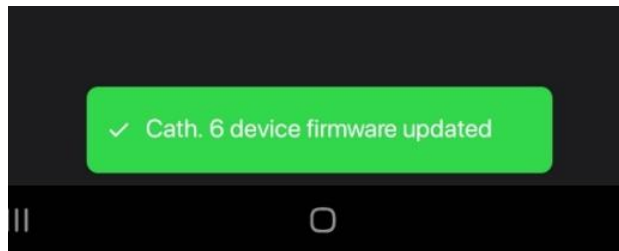

Figure 61: Stream™ screen message showing that Origin™ firmware update was completed.

Update interrupted: If the update was interrupted the prompt shown below will be shown, instructing the user to go back to the patient monitoring screen so that Stream™ can continue the update.

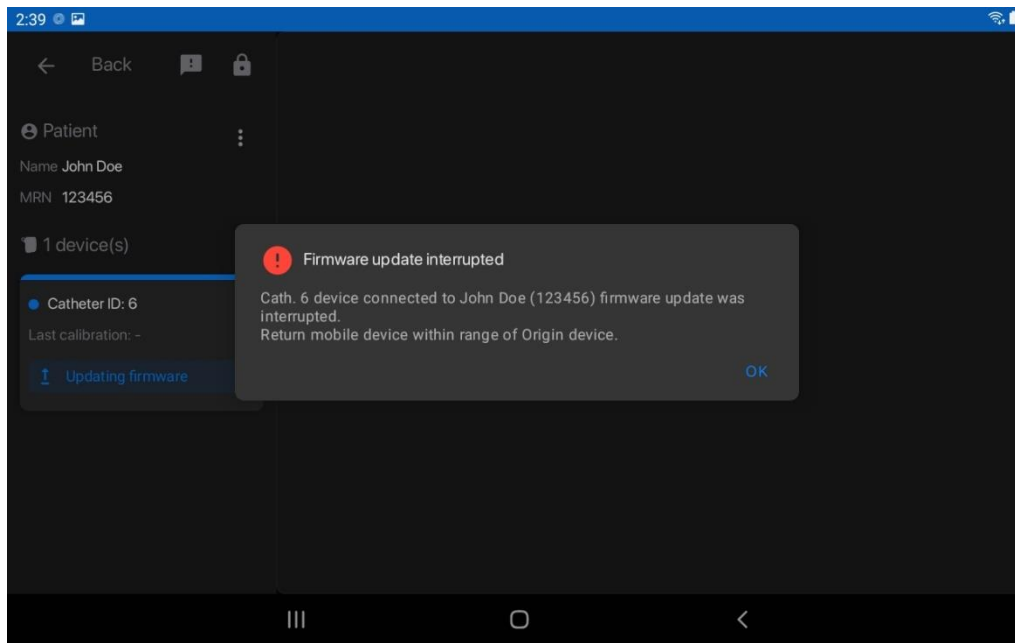

Figure 62: Stream™ screen showing that Origin™ firmware update has been interrupted.



NOTE

- When *Origin™* is undergoing an Over the Air (OTA) update, please keep FluidAI's mobile device near *Origin™*.
- A Bluetooth connection is required between the *Origin™* inline device and the *Stream™ App* into complete any firmware updates.
- *Origin™* will show a solid Yellow LED while it is waiting for *Stream™* to send the update package. **If the solid Yellow LED persists for more than a minute, please refer to the troubleshooting in section 8.1.**
- *Origin™* will show a solid Blue LED when the firmware update starts.
- *Origin™* will automatically re-establish connection with *Stream™* upon completion.

5.11 Reviewing Patient Data

For detailed instructions on reviewing patient information, please refer to **Section 4 – Stream™ Software Application**.

Patient information can be previewed on the patient screen. The top left corner shows the patient information followed by the devices that are paired to the respective patient.

**NOTE**

- A maximum number of five (5) *Origin™* devices can be to a single patient record on Stream™ at one time.
- A maximum number of five (5) *Origin™* devices can be paired to a single mobile device.

On the right-hand side of the screen, a *leak risk* category (at the top), a chart of pH (in the middle), and conductivity (at the bottom) over the defined period of time is displayed in real-time.

Pinch-zoom and swipe gestures can be used to scroll through the patient data chart. Double tapping the chart will display all data captured by *Origin™*.

**NOTE**

- *Stream™* needs to be within 5m (line-of-sight) of *Origin™* to receive data from the device. If the patient data is not updating, move *FluidAI's* mobile device closer to *Origin™*.

5.12 Disconnecting *Origin™* from the Patient's Wound Drain

The *Origin™* inline device may operate for up to 10 days, up until drain is removed, or up until patient is discharged, whichever sooner.

To detach the device from the drainage system for any reason (e.g., device expiry/replacement). Please follow these steps:

Step 1 – Perform hand Hygiene before handling the drainage system and *Origin™*.

Step 2 – Don clean gloves.

Step 3 – Place a waterproof pad (not provided by *FluidAI Medical*) on the bed beneath the evacuator.

Step 4 – Empty the evacuator while following aseptic techniques as per standard protocol.

Step 5 – Rotate the stopcock such that the “OFF” indicator is turned to “CAL” (or pointing towards the patient) or use the tube clamp provided to impede drainage into the stopcock.

Step 6 – If applicable, remove the safety pin to detach *Origin™* from the patient's gown.

Step 7– Disconnect the drainage system's flexible tubing from the stopcock. Set *Origin™* and its tubing/stopcock on the pad.

Optional: To minimize spillage of drainage fluid rotate the stopcock such that the “OFF” indicator is turned to “DRAIN” (or pointing towards the positive pressure cap (*see Figure 24*)). Ensure that the evacuator has suction. You should be able to see all the fluid in the tubing get suctioned into the evacuator.

Step 8 – Maintaining asepsis, disconnect the short flexible tubing attached to *Origin™* from the evacuator.

Step 9– If attaching a new *Origin™*, follow instructions under **Section 5.3 – Turning “ON” and Attachment of *Origin™* to the Patient's Wound Drain**. Otherwise, continue with the next step.

Step 10 – To reattach the drainage system to the evacuator, use an alcohol swab (not provided by *FluidAI Medical*) to cleanse the one-way port on the evacuator and the long tube of the drainage system.

Step 11 – Remove the tube clamp.

Step 12 – Apply suction to the evacuator as per standard practice.

Step 13 – Follow the next section (**5.13**): *Disposal of *Origin™* Device* to discard device. Remove gloves and perform hand hygiene once used device is disposed properly.

5.13 Disposal of *Origin*™ Device

Origin™ is a single-use, disposable device.

Origin™ contains alkaline batteries. *Origin*™ must be treated as biohazardous waste. *Origin*™ must be disposed of in accordance with institutional, local, state, provincial, and/or national regulations.



WARNING

- Used *Origin*(s)™ may contain biohazardous material. Please take the necessary precautions when handling and follow applicable hospital guidelines during handling and disposal.
- Under no circumstances should devices be re-used.
- Alkaline batteries used in *Origin*™ cannot be incinerated and may explode when exposed to high heat.
- The device cannot be disposed of as unsorted municipal waste.
- After removing *Origin*™ from packaging, the device cannot be transported. It is for hospital use only.

5.14 Sending Feedback through the *Stream*™ App

You can contact *FluidAI* Support directly through *Stream*™ and submit a request for help, submit feedback, report a bug, and/or report adverse events. All messages will be directly sent to *FluidAI*'s Support team.



NOTE

An internet connection is required to submit feedback through the *Stream*™ App.

Step 1 – Select the support icon on the main dashboard (top right corner) or patient monitoring screen (top left corner) to access the support screen.

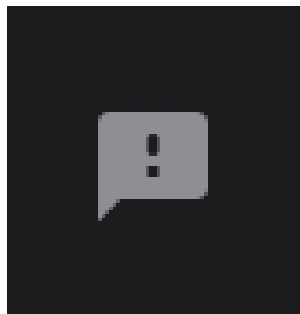

Figure 63: Support icon on *Stream*™

Step 2 – On the support screen provide a detailed description of your problem/feedback.

Step 3 – To submit the feedback, enter your name and (*Optional*) your contact information – email/phone number.

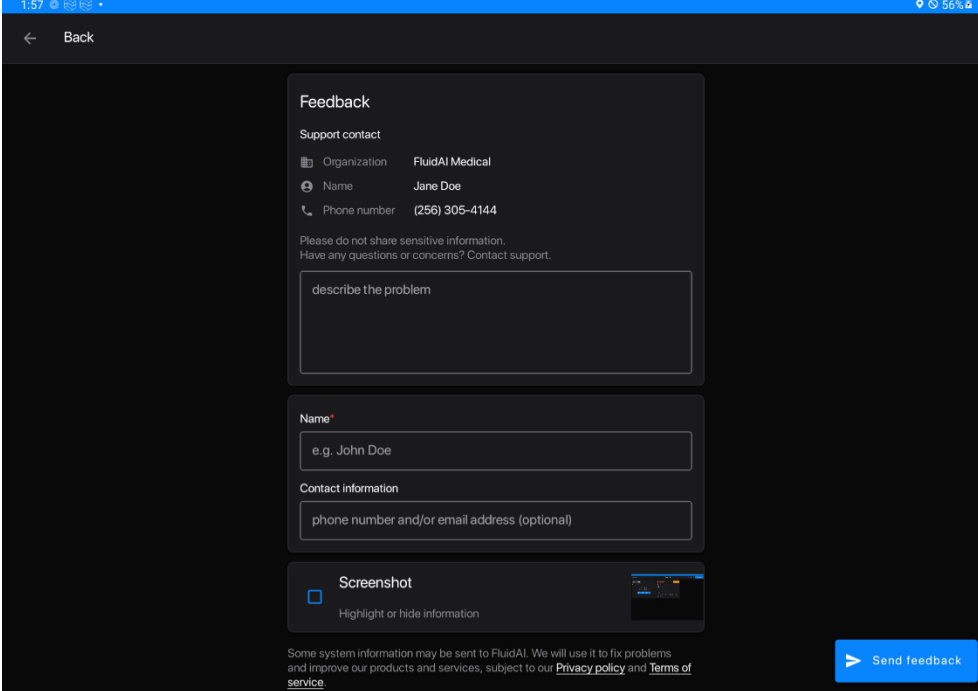

Figure 64: Support Screen on Stream™

Step 4 – Stream™ allows you to include a screenshot of the last accessed screen (main dashboard screen, patient monitoring screen, etc.). If you would like to upload the screenshot; select the tick icon next to the screenshot. Select the screenshot to highlight any issues faced and **redact any sensitive information**. Select Save changes once you complete editing.



CAUTION!

If user chooses to include screenshots, **they must redact all protected health information** prior to uploading screenshots from the Stream™ App to support tickets. The Stream™ application facilitates screenshots during the creation of a ticket as well as a prompt to redact any Protected Health Information.

Step 5 – Select “> Send Feedback” to share your feedback with the support team at FluidAI Medical.

6 System Overview

6.1 Overview

Table 9: *Origin™* specification overview

Specification	Value	Units
Operating Temperature	18-40	degree Celsius (°C)
Service life/ Active Lifetime	10	days
Shelf Life	2	years
pH response time	15	minutes
pH range	5 - 9	pH units
pH accuracy (18-35°C)	0.2	pH units
pH accuracy (above 35°C)	0.3	pH units
pH drift (per 24 hours)	0.2	pH units
pH resolution	0.05	pH units
EC range	5 - 30	mS/cm
EC response time	15	minutes
EC accuracy	5	%
EC resolution	0.1	mS/cm
RF Transmission Technology	Bluetooth Low Energy 4.1	
RF Transmission Frequency	2.360 - 2.500	GHz
RF Transmitter Power (max)	+4	dBm

6.2 Device Power

Origin™ is powered by disposable batteries and is a single use device. It is classified as an *internally powered* Medical Electrical (ME) equipment and is rated for *Continuous Operation* as per sub-clauses 6.2 and 6.6 of IEC 60601-1 v3.2 standard. See **Table 10 - *Origin™* Inline Device LED Status Table** for indicators of battery health for *Origin™*.

Stream™ will prompt the user to replace the device if the battery is low or critical by highlighting the patient card red and through a pop-up message.

6.3 Device LED Indicators

Origin™ has one built-in LED light. The LED is used to indicate the battery status of *Origin™* and evaluate if *Origin™* is connected to *Stream™*.

The LED indicates the state of the battery of *Origin™* and will slowly blink (about once every 5 seconds) throughout the lifetime of *Origin™* after it has been turned on. The table below shows the possible states of the LED and what each will indicate.

Table 10: Origin™ Inline Device LED Status Table

LED Status	Indication
Off	<i>Origin™</i> is off
Solid Blue and Purple	<i>Origin™</i> device is turning On.
Blue Fast Flashing	<i>Origin™</i> is disconnected from <i>Stream™</i> and is in pairing/enhanced connectivity mode. Battery is Viable.
Amber Fast Flashing	<i>Origin™</i> is disconnected from <i>Stream™</i> and is in pairing/enhanced connectivity mode. Battery is low and device must be replaced.
Blue Slow Flashing	<i>Origin™</i> is paired and connected to <i>Stream™</i> . Battery is Viable.
Amber Slow Flashing	<i>Origin™</i> is paired and connected to <i>Stream™</i> . Battery is low and device must be replaced.
Solid Blue	<i>Origin™</i> is undergoing an Over the Air (OTA) update. FluidAI's Mobile device must be kept near the device.
Solid Yellow	<i>Origin™</i> is preparing for an Over the Air (OTA) update. The tablet must be kept near the device. If this persists, please follow the trouble shooting procedure in section 8.3

6.4 Calibration Accessories

Origin™ contains sensors that require periodic calibration to maintain its accuracy. The accessories required for calibration are provided separately and come pre-packaged for convenience. Each calibration pack contains 3, 5cc, Luer-lock syringes that are color-coded. The table below shows the specifications for *Origin™* calibration accessories.

Table 11: Calibration Accessories Specifications

Specification	Value	Units
pH	7	pH Units
EC	12.88	mS/cm
Shelf Life	18	Months
Storage/Transportation Temperature	5 - 40	degrees Celsius (°C)
Storage/Transportation Humidity	30 - 70	% R.H

7 Care and Maintenance of *Origin*™

7.1 General

Origin™ does not require special care and/or maintenance steps besides good use practices and daily calibrations.

7.2 Cleaning and Disinfection

Origin™ is **not a sterile** device.

Origin™ may be cleaned and disinfected using common disinfectants such as ethanol or IPA.



NOTE

Origin™ is not rated to be sterilized using any methods. Sterilization may render *Origin*™ unusable and may create a safety hazard.

7.3 Servicing and Maintenance

Origin™ does not have any user-serviceable parts.



WARNING

Do not open, remove covers, or attempt repair of *Origin*™ device.

7.4 Operating and Storage Environment

Origin™ has been designed to be used within the confines of a controlled hospital environment by trained healthcare professionals. *Origin*™ is not IP rated and should not be used in environments where it could be exposed to liquids for prolonged periods of time (e.g., showers).



WARNING

- Do not use the device in the shower/bath or expose it to flowing water.
- Do not discharge a patient with *Origin*™ still attached. *Origin*™ is intended for in-hospital use only under the direct supervision of a healthcare professional. This device is not for at-home use.
- Do not use the device where the intensity of EM DISTURBANCES is high such as during Magnetic Resonance Imaging (MRI)
- Portable RF communications equipment (including peripherals such as antenna cables and external antennas) should be used no closer than 30cm (12 inches) to any part of *Origin*™. Otherwise, degradation of the performance of this equipment could result.



WARNING

- The EMISSIONS characteristics of this equipment make it suitable for use in industrial areas and hospitals (CISPR 11 Group 1 class A). If it is used in a residential environment (for which CISPR 11 class B is normally required) this equipment might not offer adequate protection to radio-frequency communication services. The user might need to take mitigation measures, such as relocating or re-orienting the equipment.

Origin™ has passed all IEC 60601-1-2: 4th edition tests for professional healthcare facility environment. Applicable enclosure port immunity tests are listed in the tables below (**Table 12 & Table 13**).

Table 12: Enclosure port immunity test results for Origin™ as per IEC 60601-1-2 Ed. 4

Phenomenon	EMC Standard/ Test Method	Immunity Test Levels
Electrostatic discharge	IEC 61000-4-2	±8kV contact ±2kV, ±4kV, ±8kV, ±15 kV Air discharge
Radiated RF EM fields	IEC 61000-4-3	3 V/m (80 MHz - 2.7 GHz) 80% AM @ 1 kHz
Proximity fields from RF wireless communications equipment	IEC 61000-4-3	Table 13 below as per IEC 60601-1-2 4 th Edition.
Rated power frequency magnetic fields	IEC 61000-4-8	30 A/m (60 Hz)

Table 13: Test specifications for ENCLOSURE PORT IMMUNITY to RF wireless communications equipment

Test Frequency (MHz)	Band ^{a)}	Service ^{a)}	Modulation ^{b)}	Maximum power (W)	Distance (m)	Immunity TEST LEVEL (V/m)
385	380-390	TETRA 400	Pulse modulation ^{b)} 18 Hz	1,8	0,3	27
450	430-470	GMRS 460, FRS 460	FM ^{c)} ± 5 kHz deviation 1kHz sine	2	0,3	28
710	704-787	LTE Band 13, 17	Pulse modulation ^{b)} 217 Hz	0,2	0,3	9
745						
780						
810	800-960	GSM 800/900, TETRA 800, iDEN 820, CDMA 850, LTE Band 5	Pulse modulation ^{b)} 18 Hz	2	0,3	28
870						
930						
1720	1700-1990	GSM 1800; CDMA 1900; GSM 1900; DECT; LTE Band 1, 3, 4, 25; UMTS	Pulse modulation ^{b)} 217 Hz	2	0,3	28
1845						
1970						
2450	2400-2570	Bluetooth, WLAN, 802.11 b/g/n, RFID 2450, LTE Band 7	Pulse modulation ^{b)} 217 Hz	2	0,3	28
5240	5100-	WLAN	Pulse modulation ^{b)} 217 Hz	0,2	0,3	9
5500	5800	802.11 a/n				
5785						

Table 14 below shows the storage and operating conditions of *Origin™*. *FluidAI Medical* does not guarantee that the device will operate correctly outside of these conditions.

Table 14: Origin™ Operating and Storage Environment Specifications

Storage and Operating Parameter	Value	Units
Temperature	5 - 40	degrees Celsius
Humidity	30 - 70	% R.H

7.5 Consumables Replacement

Replacement of consumables may be ordered through your local *FluidAI Medical* representative, calling +1 (877) 660-6378, or emailing support@fluidai.md

8 Troubleshooting and Error Messages

8.1 General Troubleshooting

Patient Measurement Data Not Updating

Origin™ sends data to *Stream™* via Bluetooth Low Energy (BLE). If data is not being received, ensure that *FluidAI Medical*'s mobile device is within 5m of the patient's *Origin™*. Check that *Origin™* is connected to *Stream™*. If connected, wait several minutes for the data to be sent over BLE to *Stream™* from *Origin™*. If *Origin™* is not connected, check that *Origin™* is still on, then press the multi-purpose button to put it in enhanced connectivity mode.

If the problem persists, contact your local *FluidAI Medical* representative.

Trapped Air in Flow Cell

On occasion, air bubbles may be trapped in *Origin™*'s flow cell, causing inaccurate pH readings. Bubbles can be cleared by turning the stopcock "OFF" towards the patient (see Figure below), then inserting and locking a saline syringe (not provided by *FluidAI Medical*) to the Infusion port, and vigorously flushing the flow cell. Alternatively, any of the accessory syringes provided by *FluidAI Medical* can be used to conduct the flush.

If an air bubble is still present (error shown on *Stream™* during calibration only)/suspected, contact your local *FluidAI Medical* representative.

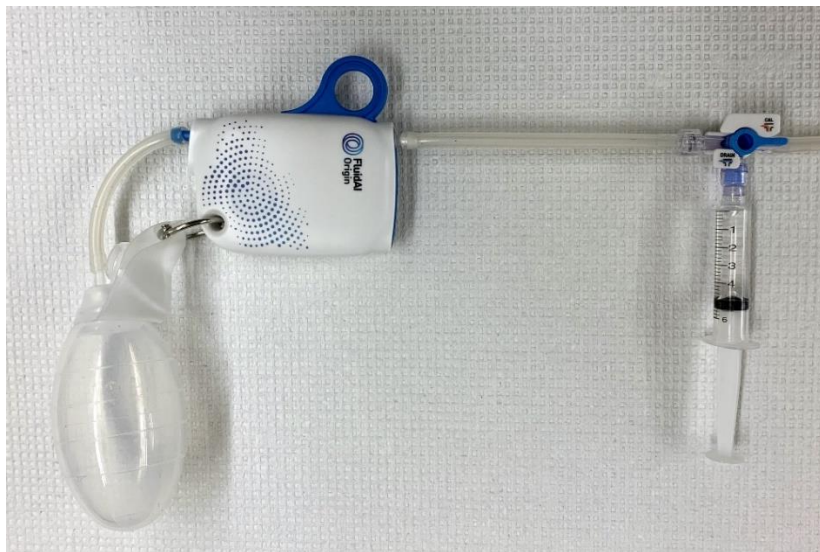

Figure 65: *Origin™* stopcock "OFF" towards the "CAL" or calibration mode

Obstructions in Flow Cell or 3-way Stopcock

On occasion, drainage fluid may contain large particulates or clots that may be lodged in *Origin™*'s flow cell. If that occurs, follow the same procedures to clear trapped air in flow cell above. Turn the stopcock “OFF” towards the patient (see **Figure 24**), then insert and lock a saline syringe to the Infusion port, and vigorously flush the flow cell.

Alternatively, any of the accessory syringes provided by *FluidAI Medical* can be used to conduct the flush.

If *Origin™* flow cell is still obstructed, replace the device, and contact your local *FluidAI Medical* representative to send the blocked device back to *FluidAI Medical*.

Solid Yellow LED (OTA update interruption)

If a solid yellow LED is persistently seen during OTA, is an indicator that the update is interrupted. Ensure that *FluidAI's mobile device* is nearby and that the Bluetooth in the *Settings* menu is “ON”. If the *Origin™*'s LED does not turn to solid Blue when the mobile device is in close proximity to *Origin™*, proceed with the following steps:







1. Turn Bluetooth OFF and then turn it back ON, if the LED doesn't turn to a solid Blue, then proceed to the next step;
2. Use the dropdown menu on the catheter card “:” to select “Connect”, the LED should turn to solid Blue as the device starts updating.







If both of the above steps fail, then please Contact your local *FluidAI Medical* representative for assistance.





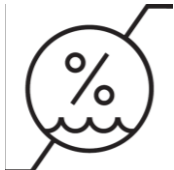

8.2 Stream™ Application Error Messages



Under the *Settings* screen within the *Stream™ App*, a list of possible error messages is available along with potential resolutions. If errors persist after trying one or more possible resolutions, contact your local *FluidAI Medical* representative.

FluidAI Medical Symbol Directory

SYMBOL	STANDARD REFERENCE	STANDARD TITLE	SYMBOL TITLE	EXPLANATORY TEXT
	ISO 15223- 1:2016 Reference no. 5.1.1. (ISO 7000-3082)	Medical devices — Symbols to be used with medical device labels, labeling, and information to be supplied – Part 1: General requirements.	Manufacturer	Indicates the medical device manufacturer
	ISO 15223- 1:2016 Reference no. 5.1.3. (ISO 7000-2497)	Medical devices — Symbols to be used with medical device labels, labeling, and information to be supplied – Part 1: General requirements.	Date of manufacture	Indicates the date when the medical device was manufactured
	ISO 15223- 1:2016 Reference no. 5.1.4. (ISO 7000-2607)	Medical devices — Symbols to be used with medical device labels, labeling, and information to be supplied – Part 1: General requirements.	Use-by date Use by date	Indicates the date after which the medical device is not to be used iso_15223 Use-by date iso_grs_7000_2607 Use by date.
	ISO 15223- 1:2016 Reference no. 5.1.5. (ISO 7000-2492)	Medical devices — Symbols to be used with medical device labels, labeling, and information to be supplied – Part 1: General requirements.	Batch code	Indicates the manufacturer's batch code so that the batch or lot can be identified
	ISO 15223- 1:2016 Reference no. 5.1.7. (ISO 7000-2498)	Medical devices — Symbols to be used with medical device labels, labeling, and information to be supplied – Part 1: General requirements.	Serial number	Indicates the manufacturer's serial number so that a specific medical device can be identified
	ISO 15223- 1:2016 Reference no. 5.1.6. (ISO 7000-2493 2004-01-15)	Medical devices — Symbols to be used with medical device labels, labeling, and information to be supplied – Part 1: General requirements	Catalogue Number	Indicates the manufacturer's catalogue number so that the medical device can be identified
	ISO 15223- 1:2016 Reference no. 5.2.7. (ISO 7000-2609)	Medical devices — Symbols to be used with medical device labels, labeling, and information to be supplied – Part 1: General requirements.	Non-sterile	Indicates a medical device that has not been subjected to a sterilization process

SYMBOL	STANDARD REFERENCE	STANDARD TITLE	SYMBOL TITLE	EXPLANATORY TEXT
	ISO 15223- 1:2016 Reference no. 5.3.1. (ISO 7000-0621)	Medical devices — Symbols to be used with medical device labels, labeling, and information to be supplied – Part 1: General requirements.	Fragile, handle with care	Indicates a medical device that can be broken or damaged if not handled carefully
	ISO 15223- 1:2016 and ISO 15223-1:2020(E) DRAFT Reference no. 5.3.4. (ISO 7000-0626)	Medical devices — Symbols to be used with medical device labels, labeling, and information to be supplied – Part 1: General requirements.	Keep dry Keep away from rain	Indicates a medical device that needs protection from moisture ISO 15223 Keep dry ISO 7000 Keep away from rain
	ISO 15223- 1:2016 Reference no. 5.3.7. (ISO 7000-0632)	Medical devices — Symbols to be used with medical device labels, labeling, and information to be supplied – Part 1: General requirements.	Temperature limit	Indicates the temperature limits to which the medical device can be safely exposed
	ISO 15223- 1:2016 Reference no. 5.3.8. (ISO 7000-2620)	Medical devices — Symbols to be used with medical device labels, labeling, and information to be supplied – Part 1: General requirements.	Humidity limitation	Indicates the range of humidity which the medical device can be safely exposed
	ISO 15223-1:2016E Reference no. 5.4.2. (ISO 7000- 1051)	Medical devices — Symbols to be used with medical device labels, labeling, and information to be supplied – Part 1: General requirements.	Do not re-use	Indicates a medical device that is intended for one single use only NOTE: Synonyms for “Do not reuse” are “single use” and “use only once”.
	ISO 7010-M002	ISO 7010—Graphical Symbols—Safety Colors and Safety Signs— Registered Safety Signs	Follow Instructions for Use	To signify that the instruction manual/booklet must be read
	ISO 15223- 1:2016 Reference no. 5.4.4. (ISO 7000-0434A)	Medical devices — Symbols to be used with medical device labels, labeling, and information to be supplied – Part 1: General requirements.	Caution	To indicate that caution is necessary when operating the device or control close to where the symbol is placed, or to indicate that the current situation needs operator awareness or operator action in order to

SYMBOL	STANDARD REFERENCE	STANDARD TITLE	SYMBOL TITLE	EXPLANATORY TEXT
				avoid undesirable consequences
	ISO 15223- 1:2016 Reference no. 5.7.1. (ISO 7000-2610)	Medical devices — Symbols to be used with medical device labels, labeling, and information to be supplied – Part 1: General requirements.	Patient number	Indicates a unique number associated with an individual patient
	ISO/DIS 15223-1:2020(E) DRAFT Reference no. 5.7.7	Medical Devices — Symbols to be used with medical device labels, labeling, and information to be supplied — Part 1: General requirements. (Draft of New Version)	Medical device	Indicates the item is a medical device
	IEC 60417 Reference no. ISO 7000-5001B	Graphic symbols for use on electrical equipment	Battery, general	On battery powered equipment
	ASTM F2503-20 Reference no. Table 2, Symbol 7.3.3; 7.4.9.1; Fig. 9	Standard Practice for Marking Medical Devices and other Items for safety in the Magnetic Resonance Environment	MR Unsafe	3.1.14: An item which poses unacceptable risks to the patient, medical staff or other persons within the MR environment
	BS EN 50419 DIRECTIVE 2012/19/ EU (WEEE)	N/A	Collect separately	Separate collection for waste of electrical and electronic equipment. Do not dispose of battery in municipal waste. The symbol indicates separate collection for battery is required.
Rx only	21 CFR 801.15 21 CFR 801.109	N/A	Prescription Use Only	Caution: Federal law (USA) restricts this device to sale by or on the order of a licensed healthcare practitioner.
	Federal Communications Commission	Federal Communications Commission (FCC) Declaration of Conformity (DoC) Logo	Federal Communications Commission	Meets FCC requirements per 21 CFR Part 15

SYMBOL	STANDARD REFERENCE	STANDARD TITLE	SYMBOL TITLE	EXPLANATORY TEXT
	N/A	N/A	Bluetooth Connection	Bluetooth Enabled Technology
	ISO 15223-1:2016E Reference no. 5.4.1. (ISO 7000-0659)	Medical devices — Symbols to be used with medical device labels, labeling, and information to be supplied – Part 1: General requirements.	Biological Risks	Indicates that there are potential biological risks associated with the medical device
	IEC 60417 - 5333	Graphical Symbols for Use on Equipment	Type BF applied part	To identify a type BF applied part complying with IEC 60601-1